

# PRICE LIST 2024

# HOWE

## FLEXIBILITY DELIVERED WITH PASSION



# Table of Content

## Chairs

40/4	4
Side chair	4
Side chair - upholstered	5
Side chair Xtra	6
Arm chair	7
Arm chair - upholstered	8
Swivel	9
Swivel - upholstered	10
Bar and Lounge	11
Metal and Wood	12
SixE	13
4-leg	13
4-leg on castors	14
Sled	15
Barstool	16
Swivel	17
Learn	18
MN1	19
Cantilever	19
X-base	20
5-star	21
AS100	22
Accessories for chairs	23
Notes for chairs	30

Upholstery collection	31
-----------------------	----



# Table of Content

## Tables

Moveo	36
Training	36
Meeting	37
Conference, modular	38
Conference, stand alone	39
Modesty panel	40
Simpla	41
Tables	41
Modesty panel	43
Tempest	44
Flip top	44
Fold	46
Fix	49
Flip top café	51
Fix café and lounge	52
Flip top bar	53
Fix bar	54
Drop-in top	55
Modesty panel	56
Tutor	57
Usu	58
AS table series	59
AS400	59
AS500	60
Folding Surfaces	61
Other accessories for tables	62
Notes for tables	70
Finish overview	72
Sales Terms	77
Shipping zone rates	81
Warranty	82



# 40/4 side chair - polyamide and veneer

By David Rowland

Most people see the 40/4 as a pioneering design that has stood the test of time. We like to think of it as a legacy that continues to move you in new ways.

- 10 year warranty
- Stacks 40 chairs on a dolly
- EN 15373 / ANSI/BIFMA X5.1 – M7.1
- GreenTag<sup>Cert™</sup>
- **Quick ship - LINK**
- FSC wood certified

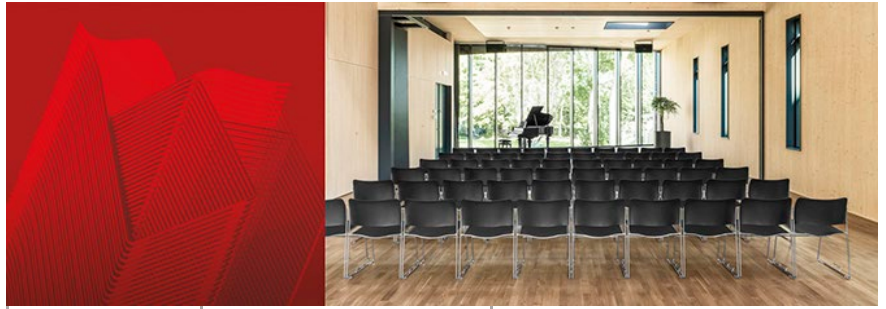

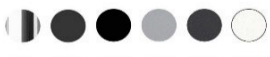
	POLYAMIDE (DPA)		VENEER (DVA)		
STANDARD FRAME COLOURS	PA200 ● PA100 ● V2 ● V1 ● LW17 ●	PA300 ○ PA110 ● V3 ● V5 ● LW30 ●	PA250 ● V13 ● V15 ● V12 ●		
 B1 B6 B7 B9 B10 B30					
RAL K7 colours available at customer request	\$	\$	\$	\$	\$
Non linking (RA) 14.3 lbs					
	489	528	711	759	823
Brace linking (BA) 14.6 lbs					
	556	595	780	828	892
Side chair outdoor (DOARA) 14.3 lbs					
	731	770	N/A	N/A	N/A

Price List 2024 - USD excl. sales tax - Version 1.1

Felt glides	20	\$
Fee per RAL K7 colour for frames (for one colour if below 200 pcs)	+520	\$
Fee per RAL K7 colour for veneer (for one colour if below 200 pcs)	+520	\$

# 40/4 side chair upholstered

By David Rowland

Most people see the 40/4 as a pioneering design that has stood the test of time. We like to think of it as a legacy that continues to move you in new ways.

- 10 year warranty
- Stacks 25 chairs on a dolly
- EN 16139 / Ansi/Bifma X5.1
- GreenTag<sup>Cert™</sup>
- FSC wood certified



## STANDARD FRAME COLOURS



RAL K7 colours available at customer request

## Non linking (RA)

13.9 lbs

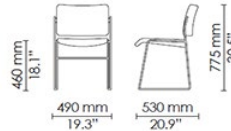

## Brace linking (BA)

14.3 lbs

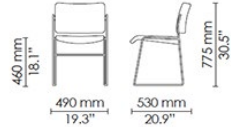

GROUP	SEAT UPHOLSTERED					FULLY UPHOLSTERED (DUA)
	POLYAMIDE (DSA)		VENEER (DTA)			
	PA200 PA300	PA100 PA110 PA250 PA260 PA320 PA360 PA380 PA370	V2 V3 V13	V1 V5 V15 V12	LW17 LW30	
	\$	\$	\$	\$	\$	\$
<b>COM</b>	627	651	848	878	922	711
<b>1</b>	666	690	887	917	961	767
<b>2</b>	718	742	939	969	1013	841
<b>3</b>	768	792	989	1019	1063	914
<b>4</b>	845	869	1066	1096	1140	1023
<b>5</b>	871	895	1092	1122	1166	1059
<b>COL</b>	785	809	1006	1036	1080	938
<b>LUBL</b>	845	869	1066	1096	1140	1023
<b>LUCL</b>	947	971	1168	1198	1242	1169
<b>LSL</b>	1109	1133	1330	1360	1404	1399
<b>COM</b>	694	718	915	945	989	780
<b>1</b>	733	757	954	984	1028	836
<b>2</b>	785	809	1006	1036	1080	910
<b>3</b>	835	859	1056	1086	1130	983
<b>4</b>	912	936	1133	1163	1207	1092
<b>5</b>	938	962	1159	1189	1233	1128
<b>COL</b>	852	876	1073	1103	1147	1007
<b>LUBL</b>	912	936	1133	1163	1207	1092
<b>LUCL</b>	1014	1038	1235	1265	1309	1238
<b>LSL</b>	1176	1200	1397	1427	1471	1468

Price List 2024 - USD excl. sales tax - Version 1.1

Felt glides	20	\$
Fee per RAL K7 colour for frames (for one colour if below 200 pcs)	+520	\$
Fee per RAL K7 colour for veneer (for one colour if below 200 pcs)	+520	\$

# 40/4 side chair Xtra

By David Rowland

Most people see the 40/4 as a pioneering design that has stood the test of time. We like to think of it as a legacy that continues to move you in new ways.

- 10 year warranty
- Stacks 40 chairs on a dolly
- EN 16139 / Ansi/Bifma X5.1
- GreenTag<sup>Cert™</sup>
- 1.6" wider and 0.2" higher than the standard 40/4
- FSC wood certified

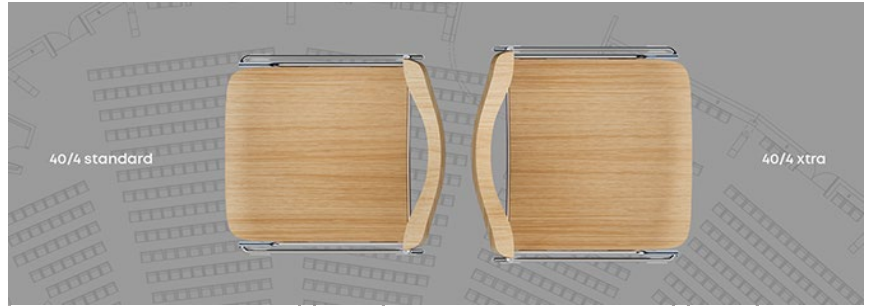

STANDARD FRAME COLOURS	VENEER (DVQ)			GROUP	VENEER WITH UPH. SEAT (DTQ)			FULLY UPHOLSTERED (DUQ)
	V2 V3 V13	V1 V5 V15 V12	LW17 LW30		V2 V3 V13	V1 V5 V15 V12	LW17 LW30	
<p>B1 B6 B7 B9 B10 B30</p> <p>RAL K7 colours available at customer request</p>	\$	\$	\$		\$	\$	\$	\$
<b>Non linking (RA)</b> 13.9 lbs 	818	866	930	<b>COM</b>	977	1007	1051	818
				<b>1</b>	1016	1046	1090	874
				<b>2</b>	1068	1098	1142	948
				<b>3</b>	1118	1148	1192	1021
				<b>4</b>	1195	1225	1269	1130
				<b>5</b>	1221	1251	1295	1166
				<b>COL</b>	1135	1165	1209	1045
				<b>LUBL</b>	1195	1225	1209	1130
				<b>LUCL</b>	1297	1327	1209	1276
				<b>LSL</b>	1459	#N/D	1209	1506
<b>Brace linking (BA)</b> 14.1 lbs 	887	935	999	<b>COM</b>	1044	1074	1118	887
				<b>1</b>	1083	1113	1157	943
				<b>2</b>	1135	1165	1209	1017
				<b>3</b>	1185	1215	1259	1090
				<b>4</b>	1262	1292	1336	1199
				<b>5</b>	1288	1318	1362	1235
				<b>COL</b>	1202	1232	1276	1114
				<b>LUBL</b>	1262	1292	1276	1199
				<b>LUCL</b>	1364	1394	1276	1345
				<b>LSL</b>	1526	1556	1276	1575

Price List 2024 - USD excl. sales tax - Version 1.1

Felt glides	20	\$
Fee per RAL K7 colour for frames (for one colour if below 200 pcs)	+520	\$
Fee per RAL K7 colour for veneer (for one colour if below 200 pcs)	+520	\$

# 40/4 armchair - polyamide and veneer

By David Rowland

Most people see the 40/4 as a pioneering design that has stood the test of time. We like to think of it as a legacy that continues to move you in new ways.

- 10 year warranty
- Stacks 40 chairs on a dolly
- EN 15373 / ANSI/BIFMA X5.1 – M7.1
- GreenTag<sup>Cert™</sup>
- FSC wood certified

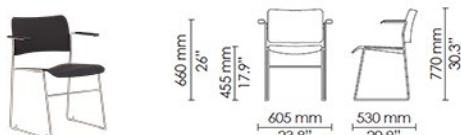
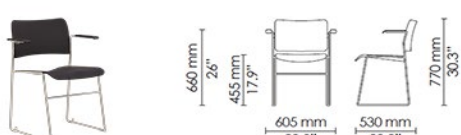
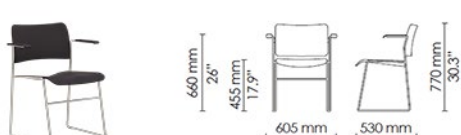

	POLYAMIDE (DPB)		VENEER (DVB)			
STANDARD FRAME COLOURS	PA200 ● PA300 ○	PA100 ● PA110 ● PA250 ● PA260 ● PA320 ● PA360 ● PA380 ● PA370 ●	V2 ● V3 ● V13 ●	V1 ● V5 ● V15 ● V12 ●	LW17 ● LW30 ○	
						
RAL K7 colours available at customer request	\$	\$	\$	\$	\$	
Non linking (RA) 17 lbs		677	716	897	945	1009
Armlinking (J) 17.2 lbs		787	826	1007	1055	1119
Armchair outdoor (DOBRA) 17 lbs		919	958	N/A	N/A	N/A

Price List 2024 - USD excl. sales tax - Version 1.1

Felt glides	20	\$
Table surface protection	+23	\$
Fee per RAL K7 colour for frames (for one colour if below 200 pcs)	+520	\$
Fee per RAL K7 colour for veneer (for one colour if below 200 pcs)	+520	\$

# 40/4 armchair upholstered

By David Rowland

Most people see the 40/4 as a pioneering design that has stood the test of time. We like to think of it as a legacy that continues to move you in new ways.

- 10 year warranty
- Stacks 25 chairs on a dolly
- EN 15373 / ANSI/BIFMA X5.1 – M7.1
- GreenTag<sup>Cert™</sup>
- FSC wood certified



## STANDARD FRAME COLOURS



RAL K7 colours available at customer request

## Non linking (RA)

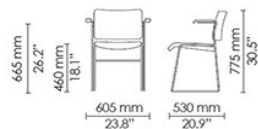

16.8 lbs

## Armlinking (J)

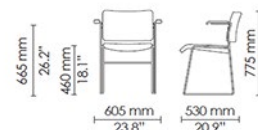

17 lbs

GROUP	SEAT UPHOLSTERED					FULLY UPHOLSTERED (DUB)		
	POLYAMIDE (DSB)		VENEER (DTB)			BLACK POLYAMIDE ARMREST	BLACK STAINED VENEER ARMREST	UPH. ARMRESTS
	PA200 PA300	PA100 PA110 PA250 PA260 PA320 PA360 PA380 PA370	V2 V3 V13	V1 V5 V15 V12	LW17 LW30			
	\$	\$	\$	\$	\$	\$	\$	\$
<b>COM</b>	815	839	1036	1066	1110	898	972	972
<b>1</b>	854	878	1075	1105	1149	954	1028	1053
<b>2</b>	906	930	1127	1157	1201	1028	1102	1143
<b>3</b>	956	980	1177	1207	1251	1101	1175	1229
<b>4</b>	1033	1057	1254	1284	1328	1210	1284	1350
<b>5</b>	1059	1083	1280	1310	1354	1246	1320	1408
<b>COL</b>	973	997	1194	1224	1268	1125	1199	1242
<b>LUBL</b>	1033	1057	1254	1284	1328	1210	1284	1350
<b>LUCL</b>	1135	1159	1356	1386	1430	1356	1430	1557
<b>LSL</b>	1297	1321	1518	1548	1592	1586	1660	1805
<b>COM</b>	925	949	1146	1176	1220	1008	1082	1082
<b>1</b>	964	988	1185	1215	1259	1064	1138	1163
<b>2</b>	1016	1040	1237	1267	1311	1138	1212	1253
<b>3</b>	1066	1090	1287	1317	1361	1211	1285	1339
<b>4</b>	1143	1167	1364	1394	1438	1320	1394	1460
<b>5</b>	1169	1193	1390	1420	1464	1356	1430	1518
<b>COL</b>	1083	1107	1304	1334	1378	1235	1309	1352
<b>LUBL</b>	1143	1167	1364	1394	1438	1320	1394	1460
<b>LUCL</b>	1245	1269	1466	1496	1540	1466	1540	1667
<b>LSL</b>	1407	1431	1628	1658	1702	1696	1770	1915

Price List 2024 - USD excl. sales tax - Version 1.1

Felt glides	20	\$
Table surface protection	+23	\$
Fee per RAL K7 colour for frames (for one colour if below 200 pcs)	+520	\$
Fee per RAL K7 colour for veneer (for one colour if below 200 pcs)	+520	\$



# 40/4 swivel - polyamide and veneer

By David Rowland

Most people see the 40/4 as a pioneering design that has stood the test of time. We like to think of it as a legacy that continues to move you in new ways.

- 10 year warranty
- Castors or glides available
- Height adjustable
- Soft castors as an option
- GreenTag<sup>Cert™</sup>
- FSC wood certified



	POLYAMIDE (DP)		VENEER (DV)			
STANDARD FRAME COLOURS	PA200 ● PA300 ○	PA100 ● PA110 ○ PA250 ● PA260 ● PA320 ● PA360 ● PA380 ● PA370 ●	V2 ● V3 ● V13 ●	V1 ● V5 ● V15 ● V12 ●	LW17 ● LW30 ○	
RAL K7 colours available at customer request						
Side chair (DPESS)	25.6 lbs					
		911	950	1 125	1 173	1 237
Armchair (DPFSA)	27.3 lbs					
		1 101	1 140	1 311	1 359	1 423

Price List 2024 - USD excl. sales tax - Version 1.1

Soft lane castors	20	\$
Fee per RAL K7 colour for frames (for one colour if below 200 pcs)	+520	\$
Fee per RAL K7 colour for veneer (for one colour if below 200 pcs)	+520	\$

# 40/4 swivel upholstered

By David Rowland

Most people see the 40/4 as a pioneering design that has stood the test of time. We like to think of it as a legacy that continues to move you in new ways.

- 10 year warranty
- Castors or glides available
- Height adjustable
- Soft lane castor as an option
- GreenTag<sup>Cert™</sup>
- FSC wood certified

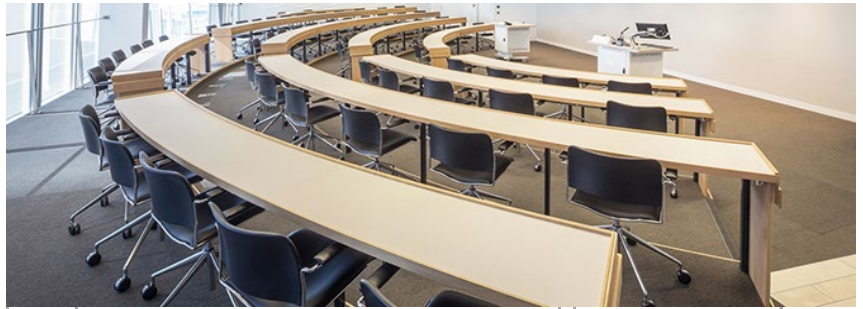

## STANDARD FRAME COLOURS



B1 B6 B7 B9 B10 B30

RAL K7 colours available at customer request

## Side chair (DUESS)

25.1 lbs

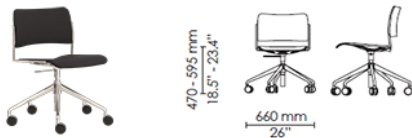

## Armchair (DUFSA)

26.9 lbs

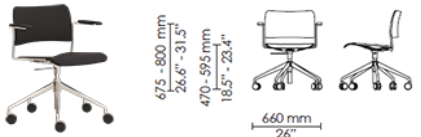

GROUP	SEAT UPHOLSTERED					FULLY UPHOLSTERED (DU)		
	POLYAMIDE (DS)		VENEER (DT)			BLACK POLYAMIDE ARMREST	BLACK STAINED VENEER ARMREST	W-W/O UPH. ARM
	PA200 PA300	PA100 PA110 PA250 PA260 PA320 PA360 PA380 PA370	V2 V3 V13	V1 V5 V15 V12	LW17 LW30			
	\$	\$	\$	\$	\$	\$	\$	\$
<b>COM</b>	1049	1073	1272	1302	1346	N/A	N/A	1135
<b>1</b>	1088	1112	1311	1341	1385	N/A	N/A	1191
<b>2</b>	1140	1164	1363	1393	1437	N/A	N/A	1265
<b>3</b>	1190	1214	1413	1443	1487	N/A	N/A	1338
<b>4</b>	1267	1291	1490	1520	1564	N/A	N/A	1447
<b>5</b>	1293	1317	1516	1546	1590	N/A	N/A	1483
<b>COL</b>	1207	1231	1430	1460	1504	N/A	N/A	1362
<b>LUBL</b>	1267	1291	1490	1520	1564	N/A	N/A	1447
<b>LUCL</b>	1369	1393	1592	1622	1666	N/A	N/A	1593
<b>LSL</b>	1531	1555	1754	1784	1828	N/A	N/A	1823
<b>COM</b>	1237	1261	1460	1490	1534	1322	1396	1396
<b>1</b>	1276	1300	1499	1529	1573	1378	1452	1477
<b>2</b>	1328	1352	1551	1581	1625	1452	1526	1567
<b>3</b>	1378	1402	1601	1631	1675	1525	1599	1653
<b>4</b>	1455	1479	1678	1708	1752	1634	1708	1774
<b>5</b>	1481	1505	1704	1734	1778	1670	1744	1832
<b>COL</b>	1395	1419	1618	1648	1692	1549	1623	1666
<b>LUBL</b>	1455	1479	1678	1708	1752	1634	1708	1774
<b>LUCL</b>	1557	1581	1780	1810	1854	1780	1854	1981
<b>LSL</b>	1719	1743	1942	1972	2016	2010	2084	2229

Price List 2024 - USD excl. sales tax - Version 1.1

Soft lane castors	20	\$
Fee per RAL K7 colour for frames (for one colour if below 200 pcs)	+520	\$
Fee per RAL K7 colour for veneer (for one colour if below 200 pcs)	+520	\$

# 40/4 barstool and lounge chair

By David Rowland

Most people see the 40/4 as a pioneering design that has stood the test of time. We like to think of it as a legacy that continues to move you in new ways.

- 10 year warranty
- Stacks up to 10 barstools on the follor
- Stacks up to 20 lounge chairs on the floor
- EN 15373 / ANSI/BIFMA X5.1
- FSC wood certified
- GreenTag<sup>Cert™</sup>



STANDARD FRAME COLOURS	POLYAMIDE		VENEER			FULLY UPHOLSTERED	
	GROUP	PRICE	GROUP	PRICE	GROUP	PRICE	PRICE
<p>B1 B6 B7 B9 B10 B30</p> <p>RAL K7 colours available at customer request</p>	PA200 ● PA100 ● V2 ● V1 ● LW17 ● PA300 ○ PA110 ● V3 ● V5 ● LW30 ● PA250 ● V13 ● V15 ● PA260 ● V12 ● PA320 ● PA360 ● PA380 ● PA370 ●	\$	\$	\$	\$	\$	
Lounge chair (DVDRA) 13.2 lbs 	N/A	N/A	895	943	1 007		
Barstool (DPCAA) 22.9 lbs 	900	939	1 123	1 171	1 235		
Barstool counter height (DPCCA) 20.3 lbs 	900	939	1 123	1 171	1 235		
Barstool outdoor (DOCCA) 22.9 lbs 	1 144	1 183	N/A	N/A	N/A		

COM	984
1	1040
2	1114
3	1187
4	1296
5	1332
COL	1211
LUBL	1296
LUCL	1442
LSL	1672
COM	1123
1	1179
2	1253
3	1326
4	1435
5	1471
COL	1350
LUBL	1435
LUCL	1581
LSL	1811
COM	1123
1	1179
2	1253
3	1326
4	1435
5	1471
COL	1350
LUBL	1435
LUCL	1581
LSL	1811

Price List 2024 - USD excl. sales tax - Version 1.1

Felt glides	20	\$
Fee per RAL K7 colour for frames (for one colour if below 200 pcs)	+520	\$
Fee per RAL K7 colour for veneer (for one colour if below 200 pcs)	+520	\$



# SixE 4-leg

By PearsonLloyd

No matter how you look at SixE, it presents itself as a perfectly bold move – bending the rules of how comfortable a simple polypropylene shell chair can be.

- 10 year warranty
- SixE stacks up to 25 chairs on a dolly
- GreenTag<sup>Cert™</sup>
- **Quick ship - LINK**



	POLYPROPYLENE (EPAMA/EPBMA)		UPHOLSTERY				
	Standard frame colours:  B1 B6 B7 B9 B10 B30 Choose matching frame and shell colour without additional costs: 	RECYCLED PP200 ● PP100 ● PP300 ○ PP310 ● PP270 ● PP120 ● PP340 ● PP350 ●	GROUP	SEAT UPH.		FULLY UPH.	
				BLACK (EFA/EFB)	COLOUR (EFA/EFB)	NO ARM (EUA)	BLACK ARM (EUB)
RAL K7 colours available at customer request	\$	\$		\$	\$	\$	\$
Sidechair (EPAMA) 11 lbs		420					
Sidechair with Quicklinking (EPAMA-R) 11 lbs		497					
Armchair (EPBMA) 12.6 lbs		545					
Armchair with armlinking (EPBMA-Y) 12.6 lbs		566					
			COM				
			1				
			2				
			3				
			4				
			5				
			COL				
			LUBL				
			LUCL				
			LSL				

Price List 2024 - USD excl. sales tax - Version 1.1

Felt glides 21 \$

Fee per RAL K7 colour for frames (for one colour if below 200 pcs) +520 \$



# SixE sled

By PearsonLloyd

No matter how you look at SixE, it presents itself as a perfectly bold move – bending the rules of how comfortable a simple polypropylene shell chair can be.

- 10 year warranty
- SixE stacks up to 25 chairs on a dolly
- GreenTag<sup>Cert™</sup>



Photo: Steve Hall / Architect: Eastlake Studio

	POLYPROPOYLENE (EPA/EPB)		UPHOLSTERY				
	PP200	RECYCLED PP200	GROUP	SEAT UPH.		FULLY UPH.	
				BLACK (EFA/ EFB)	COLOUR (EFA/ EFB)	NO ARM (EUA)	BLACK ARM (EUB)
<p>Standard frame colours:</p> <p>B1 B6 B7 B9 B10 B30</p> <p>Choose matching frame and shell colour without additional costs:</p> <p>RAL K7 colours available at customer request</p>	<p>PP100 ●</p> <p>PP300 ○</p> <p>PP310 ●</p> <p>PP270 ●</p> <p>PP120 ●</p> <p>PP340 ●</p> <p>PP350 ●</p>	<p>RECYCLED PP100 ●</p> <p>PP300 ○</p> <p>PP120 ●</p>					
	\$	\$		\$	\$	\$	\$
<p>Sidechair (EPARB) 13.2 lbs</p>	510	558	<b>COM</b>	751	799	1154	N/A
			<b>1</b>	782	830	1250	N/A
			<b>2</b>	816	864	1348	N/A
			<b>3</b>	841	889	1425	N/A
			<b>4</b>	883	931	1553	N/A
			<b>5</b>	926	974	1676	N/A
			<b>COL</b>	862	910	N/A	N/A
			<b>LUBL</b>	883	931	N/A	N/A
			<b>LUCL</b>	985	1033	N/A	N/A
			<b>LSL</b>	1095	1143	N/A	N/A
<p>Sidechair with bracelinking (EPABB) 13.7 lbs</p>	589	637	<b>COM</b>	833	881	1233	N/A
			<b>1</b>	864	912	1329	N/A
			<b>2</b>	898	946	1427	N/A
			<b>3</b>	923	971	1504	N/A
			<b>4</b>	965	1013	1632	N/A
			<b>5</b>	1008	1056	1755	N/A
			<b>COL</b>	944	992	N/A	N/A
			<b>LUBL</b>	965	1013	N/A	N/A
			<b>LUCL</b>	1067	1115	N/A	N/A
			<b>LSL</b>	1177	1225	N/A	N/A
<p>Armchair (EPBRB) 16.1 lbs</p>	635	683	<b>COM</b>	885	933	N/A	1277
			<b>1</b>	916	964	N/A	1373
			<b>2</b>	950	998	N/A	1471
			<b>3</b>	975	1023	N/A	1548
			<b>4</b>	1017	1065	N/A	1676
			<b>5</b>	1060	1108	N/A	1799
			<b>COL</b>	996	1044	N/A	N/A
			<b>LUBL</b>	1017	1065	N/A	N/A
			<b>LUCL</b>	1119	1167	N/A	N/A
			<b>LSL</b>	1229	1277	N/A	N/A
<p>Armchair with armlinking (EPBRB-Y) 16.1 lbs</p>	656	704	<b>COM</b>	906	954	N/A	1298
			<b>1</b>	937	985	N/A	1394
			<b>2</b>	971	1019	N/A	1492
			<b>3</b>	996	1044	N/A	1569
			<b>4</b>	1038	1086	N/A	1697
			<b>5</b>	1081	1129	N/A	1820
			<b>COL</b>	1017	1065	N/A	N/A
			<b>LUBL</b>	1038	1086	N/A	N/A
			<b>LUCL</b>	1140	1188	N/A	N/A
			<b>LSL</b>	1250	1298	N/A	N/A

Price List 2024 - USD excl. sales tax - Version 1.1

Felt glides 21 \$

Fee per RAL K7 colour for frames (for one colour if below 200 pcs) +520 \$







# SixE swivel

By PearsonLloyd

No matter how you look at SixE, it presents itself as a perfectly bold move. – bending the rules of how comfortable a simple polypropylene shell chair can be.

- 10\* year warranty
- Design for Disassembly
- GreenTag<sup>Cert™</sup>

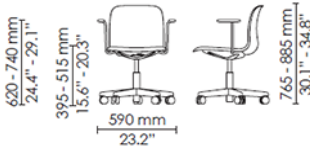

Standard frame colours: ● B10 BAIN - HOWE Grey	POLYPROPYLENE (EPEES/EPFES)		UPHOLSTERY				
	PP200 ●	PP100 ● PP300 ○ PP310 ● PP270 ● PP120 ● PP340 ● PP350 ●	RECYCLED PP200 ●	RECYCLED PP100 ● PP300 ○ PP120 ●	SEAT UPH.		FULLY UPH. (EFSES/ EFTES)
					BLACK (EPO/ EPP)	COLOUR (EPO/ EPP)	
	\$	\$			\$	\$	\$
Sidechair  15.9 lbs		595	643				
Armchair  18.3 lbs		718	766				
				GROUP			
					\$	\$	\$
				COM	839	887	1236
				1	870	918	1332
				2	904	952	1430
				3	929	977	1507
				4	971	1019	1635
				5	1014	1062	1758
				COL	950	998	N/A
				LUBL	971	1019	N/A
				LUCL	1073	1121	N/A
				LSL	1183	1231	N/A
				COM	973	1021	1361
				1	1004	1052	1457
				2	1038	1086	1555
				3	1063	1111	1632
				4	1105	1153	1760
				5	1148	1196	1883
				COL	1084	1132	N/A
				LUBL	1105	1153	N/A
				LUCL	1207	1255	N/A
				LSL	1317	1365	N/A

Price List 2024 - USD excl. sales tax - Version 1.1

Soft lane castors 21 \$



# SixE Learn

By PearsonLloyd

No matter how you look at SixE, it presents itself as a perfectly bold move – bending the rules of how comfortable a simple polypropylene shell chair can be.

- 10\* year warranty
- Design for Disassembly
- Chair for active learning environments, classrooms and higher education
- GreenTag<sup>Cert™</sup>



Standard frame colours: ● B10 BAIN - HOWE Grey	POLYPROPYLENE (EPO/EPP)		UPHOLSTERY				
	PP200 ●	PP100 ● PP300 ○ PP310 ● PP270 ● PP120 ● PP340 ● PP350 ●	RECYCLED PP200 ●	RECYCLED PP100 ● PP300 ○ PP120 ●	SEAT UPH.		FULLY UPH. (EFQ/EFR)
					BLACK (EFO/EFP)	COLOUR (EFO/EFP)	
	\$	\$	GROUP	\$	\$	\$	
Learn side chair  25.8 lbs	1127	1167					
Learn armchair  28 lbs	1252	1300					
			<b>COM</b>	1421	1461	1770	
			<b>1</b>	1452	1492	1866	
			<b>2</b>	1486	1526	1964	
			<b>3</b>	1511	1551	2041	
			<b>4</b>	1553	1593	2169	
			<b>5</b>	1596	1636	2292	
			<b>COL</b>	1532	1572	N/A	
			<b>LUBL</b>	1553	1593	N/A	
			<b>LUCL</b>	1655	1695	N/A	
			<b>LSL</b>	1765	1805	N/A	
			<b>COM</b>	1555	1603	1893	
			<b>1</b>	1586	1634	1989	
			<b>2</b>	1620	1668	2087	
			<b>3</b>	1645	1693	2164	
			<b>4</b>	1687	1735	2292	
			<b>5</b>	1730	1778	2415	
			<b>COL</b>	1666	1714	N/A	
			<b>LUBL</b>	1687	1735	N/A	
			<b>LUCL</b>	1789	1837	N/A	
			<b>LSL</b>	1899	1947	N/A	

Price List 2024 - USD excl. sales tax - Version 1.1

Soft lane castors	21	\$
Bag hook	52	\$
Cupholder	46	\$

# MN1 cantilever

By Morten Nikolajsen

Whenever comfort, classic lines, and functionality are vital, the MN1 chair is the obvious choice.

- 5 year warranty
- Stacks 5 chairs
- FSC certified
- Design for Disassembly



Standard base finish is chrome Black base and armrests as an option Standard armrests is polished aluminium	GROUP	MESH (KELCC/KELCD)		FULLY UPH. (KYLCC/KYLCD)		Black base w. or w/o black armrests	Armrest pad with chrome or black base		
		V3	LW25 LW17	V3	LW25 LW17		Uph. armrests	Veneer armrests	
		Back frame	Back frame	Back frame	Back frame				
		Oak	Black or walnut stained	Oak	Black or walnut stained				
		\$	\$	\$	\$	\$	\$	\$	
Side chair, normal back (A)	19.8 lbs	COM	1379	1467	1548	1636	+46	+N/A	+N/A
		1	1406	1494	1631	1719			
		2	1437	1525	1715	1803			
		3	1467	1555	1815	1903			
		4	1531	1619	2001	2089			
		5	1552	1640	2064	2152			
		COL	1508	1596	1934	2022			
		LUBL	1531	1619	2001	2089			
		LUCL	1684	1772	2460	2548			
		LSL	1867	1955	N/A	3099			
Side chair, high back (B)	20.7 lbs	COM	1515	1603	1682	1770			
		1	1542	1630	1765	1853			
		2	1573	1661	1849	1937			
		3	1603	1691	1949	2037			
		4	1667	1755	2135	2223			
		5	1688	1776	2198	2286			
		COL	1644	1732	2068	2156			
		LUBL	1667	1755	2135	2223			
		LUCL	1820	1908	2594	2682			
		LSL	N/A	2091	3145	3233			
Armchair, normal back (A)	20.9 lbs	COM	1510	1598	1548	1767	+90	+303	+204
		1	1537	1625	1762	1850			
		2	1568	1656	1846	1934			
		3	1598	1686	1946	2034			
		4	1662	1750	2132	2220			
		5	1683	1771	2195	2283			
		COL	1639	1727	2065	2153			
		LUBL	1662	1750	2132	2220			
		LUCL	1815	1903	2591	2679			
		LSL	1998	2086	3142	3230			
Armchair, high back (B)	21.8 lbs	COM	1646	1734	1813	1901			
		1	1673	1761	1896	1984			
		2	1704	1792	1980	2068			
		3	1734	1822	2080	2168			
		4	1798	1886	2266	2354			
		5	1819	1907	2329	2417			
		COL	1775	1863	2199	2287			
		LUBL	1798	1886	2266	2354			
		LUCL	1951	2039	2725	2813			
		LSL	2134	2222	3276	3364			

Price list 2024 - USD excl. V.A.T. - Version 1.1

Felt glides 42 \$

# MN1 X-base

By Morten Nikolajsen

Whenever comfort, classic lines, and functionality are vital, the MN1 chair is the obvious choice.

- 5 year warranty
- Simple and elegant aesthetics
- Design for Disassembly
- Height adjustable
- FSC certified



Black base and armrests as an option Standard base and armrests is polished aluminium	GROUP	MESH		FULLY UPH.		Black base w. or w/o black armrests	Armrest pad with chrome or black base				
		(KEM)		(KYM)			Upth. armrests	Veneer armrests			
		V3	LW25 LW17	V3	LW25 LW17						
		Back frame Oak	Back frame Black or walnut stained	Back frame Oak	Back frame Black or walnut stained	\$	\$	\$			
		\$	\$	\$	\$	\$	\$	\$			
<b>Side chair, normal back (A)</b> 23.1 lbs 	<b>COM</b>	1642	1730	1803	1891	+46	+N/A	+N/A			
	<b>1</b>	1669	1757	1886	1974						
	<b>2</b>	1700	1788	1970	2058						
	<b>3</b>	1730	1818	2070	2158						
	<b>4</b>	1792	1880	2256	2344						
	<b>5</b>	1815	1903	2319	2407						
	<b>COL</b>	1773	1861	2189	2277						
	<b>LUBL</b>	1792	1880	2256	2344						
	<b>LUCL</b>	1947	2035	2715	2803						
	<b>LSL</b>	2130	2218	3266	3354						
<b>Side chair, high back (B)</b> 24 lbs 	<b>COM</b>	1778	1866	1937	2025				+46	+N/A	+N/A
	<b>1</b>	1805	1893	2020	2108						
	<b>2</b>	1836	1924	2104	2192						
	<b>3</b>	1866	1954	2204	2292						
	<b>4</b>	1928	2016	2390	2478						
	<b>5</b>	1951	2039	2453	2541						
	<b>COL</b>	1909	1997	2323	2411						
	<b>LUBL</b>	1928	2016	2390	2478						
	<b>LUCL</b>	2083	2171	2849	2937						
	<b>LSL</b>	2266	2354	3400	3488						
<b>Armchair, normal back (A)</b> 24.3 lbs 	<b>COM</b>	1725	1813	1849	1937	+90	+303	+204			
	<b>1</b>	1752	1840	1932	2020						
	<b>2</b>	1783	1871	2016	2104						
	<b>3</b>	1813	1901	2116	2204						
	<b>4</b>	1875	1963	2302	2390						
	<b>5</b>	1898	1986	2365	2453						
	<b>COL</b>	1856	1944	2235	2323						
	<b>LUBL</b>	1875	1963	2302	2390						
	<b>LUCL</b>	2030	2118	2761	2849						
	<b>LSL</b>	2213	2301	3312	3400						
<b>Armchair, high back (B)</b> 25.1 lbs 	<b>COM</b>	1861	1949	1983	2071				+90	+303	+204
	<b>1</b>	1888	1976	2066	2154						
	<b>2</b>	1919	2007	2150	2238						
	<b>3</b>	1949	2037	2250	2338						
	<b>4</b>	2011	2099	2436	2524						
	<b>5</b>	2034	2122	2499	2587						
	<b>COL</b>	1992	2080	2369	2457						
	<b>LUBL</b>	2011	2099	2436	2524						
	<b>LUCL</b>	2166	2254	2895	2983						
	<b>LSL</b>	2349	2437	3446	3534						

Price list 2024 - USD excl. V.A.T. - Version 1.1

Fixed with return swivel	61	\$
Felt glides	42	\$



# AS100

By Andreas Störko

The AS series is highly inspired and highly functional. Combining elegance and utility with true mobility, the family of nesting chairs and tables leaves room for all imaginable purposes.

- 10 year warranty
- Lightweight and space-saving
- Easy to link multiple chairs for relocation
- Castors are weight activated brake castors
- Stacks horizontally as many chairs as wanted
- Return swivel mechanism with 4 positions



STANDARD ARMRESTS, SEATBAR AND BASE COLOURS



GROUP

FULLY UPHOLSTERED (DU)

\$

Side chair (CCS)

22 lbs



COM

1336

1

1397

2

1458

3

1531

4

1640

5

1710

COL

1594

LUBL

1640

LUCL

1947

LSL

2318

Armchair (CCA)

24 lbs



COM

1449

1

1510

2

1571

3

1644

4

1753

5

1823

COL

1707

LUBL

1753

LUCL

2060

LSL

2431

Price List 2024 - USD excl. sales tax - Version 1.1

Soft castors for hard floors

17

\$

# Accessories

## 40/4 Writing tablet

Most people see the 40/4 as a pioneering design that has stood the test of time. We like to think of it as a legacy that continues to move you in new ways.

All accessories are recommended for chrome frames only.



<b>Writing tablet without or with cupholder</b>		No.	Per Piece
Writing tablet without cupholder 40/4 writing tablet, chrome frame, 0.4" compact laminate Left and right version is available			\$
No Cupholder	Black	DAZS	329
No Cupholder	White	DAZS	329
Cupholder	Black	DAZS_Y	372
Cupholder	White	DAZS_Y	372
<b>40/4 and SixE Transporter for writing tablets</b>			
Writing tablet dolly, up to 18 pcs. Dolly with 3 boxes, length: 16", depth: 24", height: 55".			Per Transporter
Writing tablet dolly, up to 36 pcs. Double dolly with 6 boxes, length: 32", depth: 24", height: 55".			\$
18 Pcs	3 boxes	404WTDLY01	1001
36 pcs	6 boxes	404WTDLY02	2002



Price List 2024 - USD excl. sales tax - Version 1.1











# Accessories

## 40/4 Linking

Most people see the 40/4 as a pioneering design that has stood the test of time. We like to think of it as a legacy that continues to move you in new ways.

All accessories are recommended for chrome frames only.

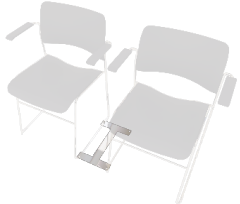

LD linking	No.	Per Piece		
Width between seats: 2.6". Linking side chair to side chair; allows to link chairs in a straight line.		\$		
40/4 linking device LD1H in chrome	404ACCLD1H	57		
Width between seats: 4.9". Linking: side chair to side chair; side chair to armchair; allows to link chairs in a straight line.				
40/4 linking device LD2H in chrome	404ACCLD2H	72		
Width between seats: 7.3" Linking: side chair to side chair; side chair to armchair; armchair to armchair; allows to link chairs in a straight line.				
40/4 linking device LD3H in chrome	404ACCLD3H	79		
Width between seats: 3.2" Linking side chair to side chair; allows to form the arc of chairs; the radius is adjustable, 0-12 degrees.				
40/4 radius linking device LD2RL in chrome	404ACCLD2R L	86		
Width between seats: 7.9" Linking armchairs with writing tablets to armchairs with writing tablets; allows to link chairs in a straight line.				
40/4 linking device LD4S in chrome	404ACCLD4S	100		
Width between seats: 2.75" Linking side chair to side chair; allows to link chairs in a straight line. Recommended for public spaces where EN 14703 is a requirement.				
40/4 safety linking device LD5S in chrome	404ACCLD5S	86		

Price List 2024 - USD excl. sales tax - Version 1.1





# Accessories

## 40/4 Dolly and Glides

Most people see the 40/4 as a pioneering design that has stood the test of time. We like to think of it as a legacy that continues to move you in new ways.

All accessories are recommended for chrome frames only.



<b>Dollies</b>			No.	Per Piece	
All accessories recommended for chrome frames only. Dollies suit side chairs and arm chairs in polyamide, veneer, or full upholstery. For dollies to other versions of the 40/4 chair - please ask HOWE					
				\$	
Hook/eye, fin linking or without linking			DLYSSAASF10	875	
Brace linking			DLYSSBCSF10	875	
<b>Extra glides with felt</b>				Per Piece	
				\$	
For hook/eye and fin-linking chairs on chrome frames					
Transparent female glides with felt with screws			02328WS	7	
Transparent male glides with felt with screws			02329WS	7	
Transparent regular glides with felt with pin			02352	7	
For non-linking chairs; for linking armchairs and for brace-linking side chairs					
Transparent regular glides with felt with pin			02352	7	
For bar chairs					
Transparent bar glides with felt for both chrome and painted frames			17330	7	
<b>Extra glides without felt</b>				Per Piece	
				\$	
For hook/eye and fin-linking chairs on chrome frames					
Transparent female glides without felt with screws			02325WS	6	
Transparent male glides without felt with screws			02326WS	6	
Transparent regular glides without felt with pin			02351	6	
For non-linking chairs; for linking armchairs and for brace-linking side chairs					
Transparent regular glides without felt with pin			02351	6	
For bar chairs					
Transparent bar glides with felt for both chrome and painted frames			17327	6	

Price List 2024 - USD excl. sales tax - Version 1.1

# Accessories

## 40/4 Linking items and book holders

Most people see the 40/4 as a pioneering design that has stood the test of time. We like to think of it as a legacy that continues to move you in new ways.

All accessories are recommended for chrome frames only.



LD linking continued		No.	Per Piece	
Width between seats: 2.75" Linking side chair to side chair; allows to link chairs in a straight line. Recommended for public spaces where EN 14703 is a requirement.			\$	
40/4 safety linking device LD55	404ACCLD55	86		
Cup holder for 40/4 safety linking device LD55	404ACCLD55 CUP	11		
Numbering for 40/4 safety linking device LD55	404ACCLD55 NUM	11		
Linking tool				
40/4 Linking tool  In chrome. An aid to the linking/unlinking operation of side chairs with integrated linking.				
Linking tool (for side chairs with integrated linking)	404ACC0300 101	72		
Row spacer bar  In HOWE grey powdercoating with rubber lock, allows a 13.78" aisle between rows.				
Row spacer bar for armchairs, 13.78" distance between the rows	404ACC027A 350	93		
Row spacer bar for side chairs, 13.78" distance between the rows	04ACC027S35	93		
Bookholders				
40/4 book rack in chrome				
Book rack (for side chairs and armchairs)	404ACC0290 101	172		
Hymn book holder  In chrome, 4.72" high and 6.89" long; 6.1" wide (distance between front legs of chairs) with integrated linking. Note! Hymn book holder does not work with the writing tablet.				
Hymn book holder (for side chairs and armchairs, non-linking)	404ACC0280 101	100		

# Accessories

## 40/4 Numbering tag

Most people see the 40/4 as a pioneering design that has stood the test of time. We like to think of it as a legacy that continues to move you in new ways.

All accessories are recommended for chrome frames only.



Numbering tags for row and seat	No.	Per Piece	
The price of one numbering tag. The start-up fee is 450 \$		\$	
40/4 Row/seat numbering tag	404SN1120	57	

Price List 2024 - USD excl. sales tax - Version 1.1

# Accessories

## SixE Writing tablet and Dolly

No matter how you look at SixE, it presents itself as a perfectly bold move – bending the rules of how comfortable a simple polypropylene shell chair can be.

All accessories are recommended for chrome frames only.



<b>Writing tablet without or with cupholder</b>		No.	Per Piece
Writing tablet without cupholder SixE writing tablet, chrome frame, 0.4" compact laminate Left and right version is available			
No Cupholder	Black	EAZS	343
No Cupholder	White	EAZS	343
Cupholder	Black	EAZS_Y	386
Cupholder	White	EAZS_Y	386
<b>40/4 and SixE Transporter for writing tablets</b>			
Writing tablet dolly, up to 18 pcs. Dolly with 3 boxes, length: 16", depth: 24", height: 55"			Per Transporter
Writing tablet dolly, up to 36 pcs. Double dolly with 6 boxes, length: 32", depth: 24", height: 55"			\$
18 Pcs	3 boxes	404WTDLY01	1001
36 pcs	6 boxes	404WTDLY02	2002
<b>Dolly for SixE 4-leg and sled</b>			
Single HOWE grey dolly with multidirectional castors Accommodates up to 25 chairs.			Per Dolly
			\$
25 chairs		22920010	1373



Price List 2024 - USD excl. sales tax - Version 1.1

# Accessories

## MN1 Dolly

Whenever comfort, classic lines, and functionality are vital, the MN1 chair is the obvious choice.



Dolly	No.	Per Piece
Dolly for MN1 chairs with cantilever base Capacity of 5 chairs, HOWE grey coated.		\$
Dolly	MN1DLYSS1B F10	958

Price List 2024 - USD excl. sales tax - Version 1.1

# Notes for chairs

Price list 2024 - USD excl. V.A.T. - Version 1.1

## General

---

HOWE Standard delivery time within North America is determined on a case-to-case basis – please contact Customer Service for details.

In case of large quantities and/or customized products delivery time is usually longer than for standard products.

For chairs with upholstery, the lead time starts being counted once fabric reaches the production line.

We recommend linking only for chrome frames.

Frame colours from RAL K5 or K7 colour card are available. For quantities < 200 chairs the colour fee is 520 USD per RAL colour. For quantities ≥ 200 chairs there is no fee. Visual impressions of particular RAL may differ on various surfaces. Preparing product's sample(s) is compulsory. Lead time to be confirmed by HOWE CS.

Stained veneer is possible with RAL colours from RAL K5 or K7 colour card. For quantities < 200 chairs the colour fee is 520 USD per RAL colour. For quantities ≥ 200 chairs there is no fee. Visual impression of particular RAL may differ on various surfaces. Preparing product's sample(s) is compulsory. Lead time to be confirmed by HOWE CS.

We recommend only stacking chairs with chrome frame.

Veneer is a natural material - differences in structure and colour may occur.

Upholstered armrests are as standard in the same fabric/leather type and colour as the seat and the back.

Soft castors are recommended for hard floors, hard castors for soft floors.

## 40/4

---

Table surface protection protects the table surface when the chairs are hung up; it may be used only for non-linking chairs.

Please be aware that extra glides are not available for wooden frames.

40/4 can be stacked on a single, double, triple or quarto dolly. Double, triple and quarto can only be used with hook/eye linking.

As standard chair top frame and its swivel base are of the same colour but be aware that they are always matched by the chrome gas lift.

Glides for linking side chairs; the whole set for one linking side chair comprises of one male glide and one female glide at the front part of the frame (reinforcing the linking in the front part of the chair frame) plus two regular glides at the rear part of the frame; whether these are glides with or without felt depends only on customer's needs.

Regular glides are suitable for non-linking side chairs, for all types of armchairs and for lounge chairs; the whole set comprises of four clear regular glides per chair.

Glides for barstool with both chrome and painted frames; the whole set comprises of four regular glides per chair.

## MN1

---

Fixed seating height - there is no possibility to install both height adjustable and return mechanism together.

Gas lift is black for black base and chrome for polished aluminium base.

## SixE

---

Bag hook is recommended only for polypropylene backs.

# FABRICS

Enhance your designs with consciously chosen fabrics of top-notch performance and sustainable profiles. If you're seeking a solution that goes beyond standard options, please contact HOWE Customer Service.

40/4  
MNI  
SixE  
AS100



62126

## CURA by Gabriel

EMEA + US/CAN price group 1

Composition: 98% post-consumer recycled polyester, 2% polyester  
Martindale: 100.000  
Washable: 60-74°C  
Cleanable: YES

Flammability CAL 117: YES  
Added flame retardant: NO  
Flammability M: NO  
Crib 5: NO  
Ecolabel: YES  
Oeko-Tex: YES

[VIEW FULL COLOR RANGE](#)

40/4  
MNI  
SixE  
AS100



64030

## EVENT by Gabriel

EMEA + US/CAN price group 1

Composition: 100% polyester  
Martindale: 100.000  
Washable: 60°C  
Cleanable: YES

Flammability CAL 117: YES  
Added flame retardant: NO  
Flammability M: NO  
Crib 5: NO  
Ecolabel: YES  
Oeko-Tex: YES

[VIEW FULL COLOR RANGE](#)

40/4  
MNI



61095

SixE  
AS100  
Needs testing

## FIGHTER by Gabriel

EMEA + US/CAN price group 1

Composition: 100% recyclable polyester  
Martindale: 130.000  
Washable: YES  
Cleanable: Only dry

Flammability CAL 117: YES  
Added flame retardant: NO  
Flammability M: NO  
Crib 5: NO  
Ecolabel: NO  
Oeko-Tex: YES

[VIEW FULL COLOR RANGE](#)

40/4  
MNI  
SixE  
AS100



Wedgwood - IF027

## MAIN LINE PLUS by Camira

EMEA + US/CAN price group 1

Composition: 67% wool, 20% flame retardant viscose, 13% viscose  
Martindale: ≥50,000  
Washable: YES  
Cleanable: YES

Flammability CAL 117: YES  
Added flame retardant: YES  
Flammability M: NO  
Crib 5: YES  
Ecolabel: NO  
Oeko-Tex: YES

[VIEW FULL COLOR RANGE](#)

40/4  
MNI  
SixE

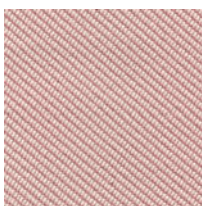

Seafarer - OOC16

## OCEANIC by Camira

EMEA + US/CAN price group 1

Composition: 100% post-consumer recycled polyester  
Martindale: ≥100,000  
Washable: 60°C  
Cleanable: YES

Flammability CAL 117: YES  
Added flame retardant: NO  
Flammability M: NO  
Crib 5: NO  
Ecolabel: YES  
Oeko-Tex: YES

[VIEW FULL COLOR RANGE](#)

40/4  
MN1  
SixE

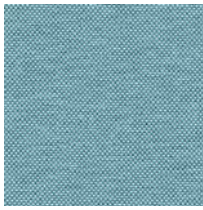

Tide - QUE12

**QUEST by Camira**

EMEA + US/CAN price group 1

Composition: 100% post-consumer recycled polyester  
Martindale: ≥100,000  
Washable: 60°C  
Cleanable: YES

Flammability CAL 117: YES  
Added flame retardant: NO  
Flammability M: NO  
Crib 5: NO  
Ecolabel: YES  
Oeko-Tex: YES

[VIEW FULL COLOR RANGE](#)

40/4  
MN1  
SixE  
AS100

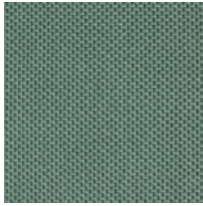

Joy - REP07

**REPLAY by Camira**

EMEA + US/CAN price group 1

Composition: 100% post-consumer recycled flame retardant polyester  
Martindale: ≥100,000  
Washable: 60°C  
Cleanable: YES

Flammability CAL 117: NO  
Added flame retardant: YES  
Flammability M: M1  
Crib 5: NO  
Ecolabel: YES  
Oeko-Tex: YES

[VIEW FULL COLOR RANGE](#)

40/4  
MN1  
SixE



Resin - EGL04

**RIVET by Camira**

EMEA + US/CAN price group 1

Composition: 100% post-consumer recycled polyester  
Martindale: ≥80,000  
Washable: 60°C  
Cleanable: YES

Flammability CAL 117: YES  
Added flame retardant: NO  
Flammability M: NO  
Crib 5: NO  
Ecolabel: YES  
Oeko-Tex: NO

[VIEW FULL COLOR RANGE](#)

40/4  
MN1  
SixE



66763

**STEP by Gabriel**

EMEA + US/CAN price group 1

Composition: 100% Trevira CS  
Martindale: 100.000  
Washable: 60-74°C  
Cleanable: YES

Flammability CAL 117: YES  
Added flame retardant: YES  
Flammability M: M1  
Crib 5: YES  
Ecolabel: YES  
Oeko-Tex: YES

[VIEW FULL COLOR RANGE](#)

40/4  
MN1  
SixE  
AS100



63138

**STEP MELANGE by Gabriel**

EMEA + US/CAN price group 1

Composition: 100% Trevira CS  
Martindale: 100.000  
Washable: 60-74°C  
Cleanable: YES

Flammability CAL 117: YES  
Added flame retardant: YES  
Flammability M: M1  
Crib 5: YES  
Ecolabel: YES  
Oeko-Tex: YES

[VIEW FULL COLOR RANGE](#)

40/4  
MN1  
SixE  
AS100

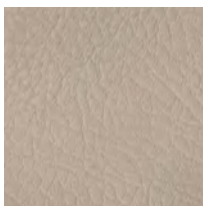

Atacama - TAN-0004

**TANNERY by Spradling**

EMEA + US/CAN price group 1

Composition: Vinyl topcoat, cotton backing  
Martindale: >100.000  
Washable: NO  
Cleanable: YES

Flammability CAL 117: YES  
Added flame retardant: YES  
Flammability M: M2  
Crib 5: NO  
Ecolabel: NO  
Oeko-Tex: NO

[VIEW FULL COLOR RANGE](#)



40/4  
MNI  
SixE

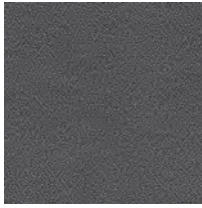

Blizzard - YS081

**XTREME by Camira**

EMEA + US/CAN price group 1

Composition: 100% post-consumer recycled flame retardant polyester  
 Martindale: ≥100,000  
 Washable: 60°C  
 Cleanable: YES

Flammability CAL 117: YES  
 Added flame retardant: YES  
 Flammability M: NO  
 Crib 5: YES  
 Ecolabel: YES  
 Oeko-Tex: YES

[VIEW FULL COLOR RANGE](#)

40/4  
MNI  
SixE  
AS100



Tooting - MLF7

**MAIN LINE FLAX by Camira**

EMEA + US/CAN price group 2

Composition: 70% virgin wool, 30% flax  
 Martindale: ≥50,000  
 Washable: NO  
 Cleanable: YES

Flammability CAL 117: YES  
 Added flame retardant: NO  
 Flammability M: NO  
 Crib 5: YES  
 Ecolabel: YES  
 Oeko-Tex: NO

[VIEW FULL COLOR RANGE](#)

40/4  
MNI  
SixE



Warrior - 466553-045

**METAPHOR by Maharam**

EMEA + US/CAN price group 2

Composition: 100% polyester  
 Martindale: 100,000 double rubs Wyzenbeek  
 Washable: NO  
 Cleanable: YES

Flammability CAL 117: YES  
 Added flame retardant: NO  
 Flammability M: NO  
 Crib 5: NO  
 Ecolabel: NO  
 Oeko-Tex: NO

[VIEW FULL COLOR RANGE](#)

40/4  
MNI

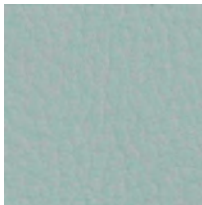

Skylight

**VALENCIA B1 by Spradling**

EMEA + US/CAN price group 2

Composition: Vinyl topcoat, cotton backing  
 Martindale: >300.000  
 Washable: NO  
 Cleanable: YES

Flammability CAL 117: YES  
 Added flame retardant: YES  
 Flammability M: M1  
 Crib 5: YES  
 Ecolabel: NO  
 Oeko-Tex: NO

[VIEW FULL COLOR RANGE](#)

40/4  
MNI  
SixE  
AS100



04031

**CRISP by Gabriel**

EMEA + US/CAN price group 3

Composition: 93% wool, 7% polyamide  
 Martindale: 200 000  
 Washable: NO  
 Cleanable: YES

Flammability CAL 117: YES  
 Added flame retardant: NO  
 Flammability M: M1  
 Crib 5: NO  
 Ecolabel: YES  
 Oeko-Tex: YES

[VIEW FULL COLOR RANGE](#)

40/4  
MNI  
SixE  
AS100



64119

**FAME by Gabriel**

EMEA + US/CAN price group 3

Composition: 95% wool, 5% polyamide  
 Martindale: 200 000  
 Washable: NO  
 Cleanable: Only dry

Flammability CAL 117: YES  
 Added flame retardant: NO  
 Flammability M: NO  
 Crib 5: YES  
 Ecolabel: YES  
 Oeko-Tex: YES

[VIEW FULL COLOR RANGE](#)

40/4  
MNI  
SixE  
AS100

0682

**REMIX 3** by Kvadrat

EMEA + US/CAN price group 3

Composition: 90% new wool, 10% nylon  
 Martindale: 100,000  
 Washable: NO  
 Cleanable: Only dry

Flammability CAL 117: YES  
 Added flame retardant: NO  
 Flammability M: NO  
 Crib 5: NO  
 Ecolabel: YES  
 Oeko-Tex: NO

[VIEW FULL COLOR RANGE](#)
40/4  
MNI  
AS100

0926

**CANVAS 2** by Kvadrat

EMEA + US/CAN price group 4

Composition: 90% new wool, 10% nylon  
 Martindale: 100,000  
 Washable: NO  
 Cleanable: Only dry

Flammability CAL 117: YES  
 Added flame retardant: NO  
 Flammability M: NO  
 Crib 5: NO  
 Ecolabel: YES  
 Oeko-Tex: NO

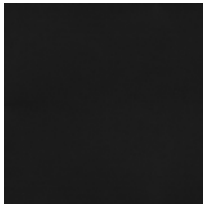
[VIEW FULL COLOR RANGE](#)
40/4  
MNI  
AS100

Black - 41599

**ULTRA** by Sørensen Leather

EMEA + US/CAN price group 4

**(TANGO), BLACK**

Composition: Protected  
 Martindale: -  
 Washable: -  
 Cleanable: -

Flammability CAL 117: YES  
 Added flame retardant: NO  
 Flammability M: -  
 Crib 5: -  
 Ecolabel: -  
 Oeko-Tex: -

[BLACK ONLY](#)

AS100

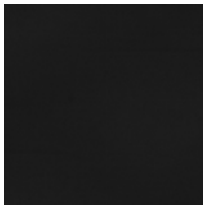

Black - 42438

**BASIC** by Sørensen Leather

EMEA + US/CAN price group 5

**(KNIGHT), BLACK**

Composition: Protected  
 Martindale: -  
 Washable: -  
 Cleanable: -

Flammability CAL 117: YES  
 Added flame retardant: NO  
 Flammability M: -  
 Crib 5: -  
 Ecolabel: -  
 Oeko-Tex: YES

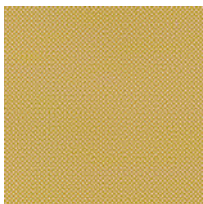
[BLACK ONLY](#)
40/4  
MNI  
Needs  
testing40/4  
MNI  
SixE  
AS100

0407

**HALLINGDAL 65** by Kvadrat

EMEA + US/CAN price group 5

Composition: 70% new wool,  
 30% viscose  
 Martindale: 100.000  
 Washable: NO  
 Cleanable: Only dry

Flammability CAL 117: YES  
 Added flame retardant: NO  
 Flammability M: NO  
 Crib 5: YES  
 Ecolabel: YES  
 Oeko-Tex: NO

[VIEW FULL COLOR RANGE](#)
40/4  
MNI  
SixE  
AS100

0865

**STEELCUT TRIO 3** by Kvadrat

EMEA + US/CAN price group 5

Composition: 90% new wool, 10% nylon  
 Martindale: 100.000  
 Washable: NO  
 Cleanable: Only dry

Flammability CAL 117: YES  
 Added flame retardant: NO  
 Flammability M: NO  
 Crib 5: NO  
 Ecolabel: YES  
 Oeko-Tex: NO

[VIEW FULL COLOR RANGE](#)

40/4  
MNI  
AS100



Burgundy - 30317

**SAVANNE** by Sørensen Leather

EMEA + US/CAN price group LSL

Composition: Semi-aniline  
Martindale: -  
Washable: -  
Cleanable: -

Flammability CAL 117: -  
Added flame retardant: -  
Flammability M: -  
Crib 5: -  
Ecolabel: -  
Oeko-Tex: YES

[VIEW FULL COLOR RANGE](#)

40/4  
MNI  
AS100



Altweiss - 41576

**ULTRA** by Sørensen Leather

EMEA + US/CAN price group LUCL

(TANGO), COLOURED

Composition: Protected  
Martindale: -  
Washable: -  
Cleanable: -

Flammability CAL 117: -  
Added flame retardant: -  
Flammability M: -  
Crib 5: -  
Ecolabel: -  
Oeko-Tex: -

[VIEW FULL COLOR RANGE](#)



# Moveo Training

By Justus Kolberg & Erik Simonsen

Easy to move thanks to a light frame, Moveo is even more flexible than your calendar. Optimum mobility is ensured by the perfectly designed wheels.

- 10 year warranty
- GreenTag<sup>Cert™</sup>
- C-leg style
- Flip top table system



	Laminate (MBB)	Veneer (MBC)	Stained veneer (MBC)																					
Laminate is with matching ABS edge. Veneer is with matching hardwood edge.  Table top thickness is 1" <div style="display: flex; justify-content: space-around; align-items: center;"> <span style="display: flex; flex-direction: column; align-items: center;"> <span style="width: 15px; height: 15px; background-color: black; border-radius: 50%;"></span> <span style="width: 15px; height: 15px; background-color: lightgrey; border-radius: 50%;"></span> <span style="width: 15px; height: 15px; background-color: white; border-radius: 50%;"></span> </span> <div style="text-align: center;">                         B6 B51 B52                     </div> </div> Standard frame* with castors with breaks *Other frame colours - see the notes	LU45 <span style="display: inline-block; width: 10px; height: 10px; background-color: black; border-radius: 50%;"></span> LU31 <span style="display: inline-block; width: 10px; height: 10px; background-color: orange; border-radius: 50%;"></span> LU35 <span style="display: inline-block; width: 10px; height: 10px; background-color: brown; border-radius: 50%;"></span> LU300 <span style="display: inline-block; width: 10px; height: 10px; background-color: lightgrey; border-radius: 50%;"></span> LU400 <span style="display: inline-block; width: 10px; height: 10px; background-color: white; border-radius: 50%;"></span> LU200 <span style="display: inline-block; width: 10px; height: 10px; background-color: black; border-radius: 50%;"></span>	VU1 <span style="display: inline-block; width: 10px; height: 10px; background-color: yellow; border-radius: 50%;"></span> VU3 <span style="display: inline-block; width: 10px; height: 10px; background-color: orange; border-radius: 50%;"></span> VU5 <span style="display: inline-block; width: 10px; height: 10px; background-color: brown; border-radius: 50%;"></span> VU15 <span style="display: inline-block; width: 10px; height: 10px; background-color: darkbrown; border-radius: 50%;"></span>	LW17 <span style="display: inline-block; width: 10px; height: 10px; background-color: black; border-radius: 50%;"></span> LW25 <span style="display: inline-block; width: 10px; height: 10px; background-color: brown; border-radius: 50%;"></span> LW30 <span style="display: inline-block; width: 10px; height: 10px; background-color: lightgrey; border-radius: 50%;"></span>	Linking																				
	\$	\$	\$																					
<table border="1" style="width: 100%; border-collapse: collapse;"> <tr> <td style="width: 15%;">Rectangular</td> <td style="width: 35%;">48"x24" (321L)</td> <td style="width: 15%; text-align: center;">2590</td> <td style="width: 15%; text-align: center;">3237</td> <td style="width: 15%; text-align: center;">3741</td> </tr> <tr> <td>Rectangular</td> <td>60"x24" (342D)</td> <td style="text-align: center;">2731</td> <td style="text-align: center;">3414</td> <td style="text-align: center;">3918</td> </tr> <tr> <td>Rectangular</td> <td>60"x30" (441O)</td> <td style="text-align: center;">2795</td> <td style="text-align: center;">3493</td> <td style="text-align: center;">3997</td> </tr> <tr> <td>Rectangular</td> <td>72"x24" (362E)</td> <td style="text-align: center;">2809</td> <td style="text-align: center;">3511</td> <td style="text-align: center;">4015</td> </tr> </table>	Rectangular	48"x24" (321L)	2590	3237	3741	Rectangular	60"x24" (342D)	2731	3414	3918	Rectangular	60"x30" (441O)	2795	3493	3997	Rectangular	72"x24" (362E)	2809	3511	4015				304
Rectangular	48"x24" (321L)	2590	3237	3741																				
Rectangular	60"x24" (342D)	2731	3414	3918																				
Rectangular	60"x30" (441O)	2795	3493	3997																				
Rectangular	72"x24" (362E)	2809	3511	4015																				
<table border="1" style="width: 100%; border-collapse: collapse;"> <tr> <td style="width: 15%;">V-shape</td> <td style="width: 35%;">48"x24" (222F)</td> <td style="width: 15%; text-align: center;">2701</td> <td style="width: 15%; text-align: center;">3376</td> <td style="width: 15%; text-align: center;">3880</td> </tr> <tr> <td>V-shape</td> <td>60"x30" (442C)</td> <td style="text-align: center;">2809</td> <td style="text-align: center;">3511</td> <td style="text-align: center;">4015</td> </tr> </table>	V-shape	48"x24" (222F)	2701	3376	3880	V-shape	60"x30" (442C)	2809	3511	4015				304										
V-shape	48"x24" (222F)	2701	3376	3880																				
V-shape	60"x30" (442C)	2809	3511	4015																				

Price List 2024 - USD excl. sales tax - Version 1.1

**Moveo Training - custom size ranges**

Rough, reference information - please verify custom sizes with CS, especially for non-rectangular tabletops

**Rectangle:** length 28"-100" | width 18"-36"





















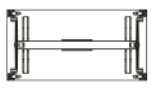

# Moveo Meeting

By Justus Kolberg & Erik Simonsen

Easy to move thanks to a light frame, Moveo is even more flexible than your calendar. Optimum mobility is ensured by the perfectly designed wheels.

- 10 year warranty
- GreenTag<sup>Cert™</sup>
- Inverted T-leg style
- Flip top table system



	Laminate (MTB)	Veneer (MTC)	Stained veneer (MTC)	
Laminate is with matching ABS edge. Veneer is with matching hardwood edge.  Table top thickness is 1"  B6 B51 B52  Standard frame* with castors with breaks *Other frame colours - see the notes	LU45  LU31  LU35  LU300  LU400  LU200 	VU1  VU3  VU5  VU15 	LW17  LW25  LW30 	Linking
	\$	\$	\$	\$
				
Rectangular 60"x30" (241O)	2798	3498	4002	304
Rectangular 72"x36" (461R)	3012	3765	4269	
				
Half-round 60"x30" (121E)	2897	3621	4125	152
				
V-Shape 60"x30" (342C)	2811	3514	4018	N/A

Price List 2024 - USD excl. sales tax - Version 1.1

## Moveo Meeting - custom size ranges

Rough, reference information - please verify custom sizes with CS, especially for non-rectangular tabletops  
 Rectangle: length 28"-100" | width 24"-36"

# Moveo Conference modular

By Justus Kolberg & Erik Simonsen

Easy to move thanks to a light frame, Moveo is even more flexible than your calendar. Optimum mobility is ensured by the perfectly designed wheels.

- 10 year warranty
- GreenTag<sup>Cert™</sup>
- Flip top table system



	Laminate (MVB)	Veneer (MVC)	Stained veneer (MVC)		
Laminate is with matching ABS edge. Veneer is with matching hardwood edge.	LU45 LU31 LU35 LU300 LU400 LU200	VU1 VU3 VU5 VU15	LW17 LW25 LW30	Linking	
Table top thickness is 1"  B6 B51 B52  Standard frame* with castors with breaks *Other frame colours - see the notes	\$	\$	\$		\$
Rectangular	88"x40" (485M)	5734	7168	8176	304
Rectangular	88"x48" (485N)	6697	8372	9380	
Half-Boat	96"x42" (786A)	6627	8284	9292	152
Half-Boat	96"x48" (786B)	7353	9192	10200	

Price List 2024 - USD excl. sales tax - Version 1.1

## Moveo Conference, Modular - custom size ranges

Rough, reference information - please verify custom sizes with CS, especially for non-rectangular tabletops  
Rectangle: length 28"-86" | width 36"-48"

# Moveo Conference stand alone

By Justus Kolberg & Erik Simonsen

Easy to move thanks to a light frame, Moveo is even more flexible than your calendar. Optimum mobility is ensured by the perfectly designed wheels.

- 10 year warranty
- GreenTag<sup>Cert™</sup>
- Inverted T-leg style
- Flip top table system

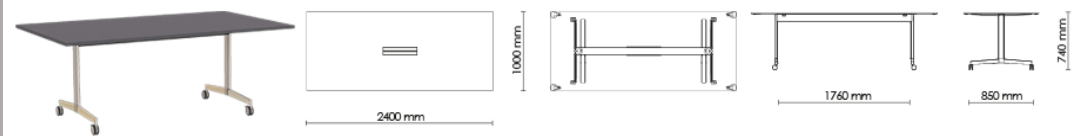
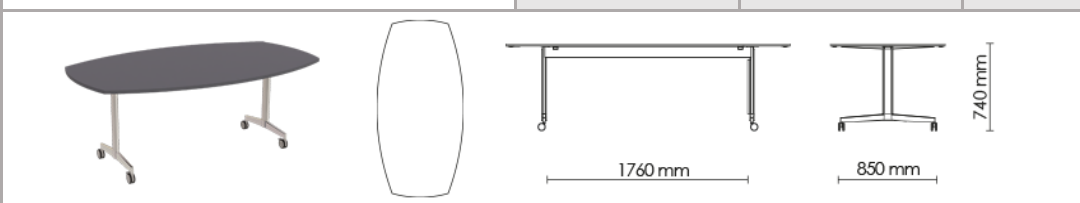

	Laminate (MRB)	Veneer (MRC)	Stained veneer (MRC)	
Laminate is with matching ABS edge. Veneer is with matching hardwood edge.  Table top thickness is 1"  B6 B51 B52  Standard frame* with castors with breaks *Other frame colours - see the notes	LU45 ● LU31 ● LU35 ● LU300 ○ LU400 ● LU200 ●	VU1 ● VU3 ● VU5 ● VU15 ●	LW17 ● LW25 ● LW30 ●	Linking
	\$	\$	\$	\$
				
Rectangular	96"x42" (472V)	5983	7479	8487
Rectangular	96"x48" (471W)	6954	8692	9700
				
Boat-shape	96"x42" (474M)	6879	8600	9608
Boat-shape	96"x48" (472W)	7605	9506	10514

Price List 2024 - USD excl. sales tax - Version 1.1

**Moveo Conference, Stand alone - custom size ranges**

Rough, reference information - please verify custom sizes with CS, especially for non-rectangular tabletops

**Rectangle:** length 48"-100" | width 36"-48"

# Moveo modesty panel

By Justus Kolberg & Erik Simonsen

Easy to move thanks to a light frame, Moveo is even more flexible than your calendar. Optimum mobility is ensured by the perfectly designed wheels.

- 10 year warranty



	Laminate	Veneer
<b>MODESTY PANEL</b>	LU45 ● LU31 ● LU35 ● LU300 ◻ LU400 ● LU200 ●	VU1 ● VU3 ● VU5 ● VU15 ● LW17 ● LW25 ● LW30 ●
Moveo modesty panel 0.35" thick and 10" high, mounted on hooks.		
	\$	\$
Beam length 975 mm (4C4C)	484	684
Beam length 1275 mm (4E4E)	532	752
Beam length 1575 mm (4H4H)	532	752

Price List 2024 - USD excl. sales tax - Version 1.1



# Simpla

By John Bollen

The unique folding system makes Simpla radically different. In addition to a minimalist and elegant silhouette, the two-piece table is flexible and space-saving.

- Lift off top
- Unique flat folding frame
- Up to 8 stacked tables on a transporter
- 5 year warranty



		Laminate (SGB)	Veneer (SGC)	
Laminate is with a matching ABS edge Veneer is standard with matching hardwood edge.		LU31 LU35 LU45 LU200 LU300 LU400	VU1 VU3 VU5 VU15 LW17 LW25 LW30	Linking
Table top thickness is 3/4" Standard frame with glides - optional to get glides and castors. Linking is incl. 2 brackets				
		\$	\$	\$
Rectangular	48"x24" (1L1L)	2326	2909	31
Rectangular	60"x30" (1O1O)	2512	3141	
Rectangular	72"x36" (1R1R)	2775	3469	
Square	30"x30" (1Z1Z)	2245	2807	31
Half-round	60"x30" (1E1E)	2690	3363	31

Price List 2024 - USD excl. sales tax - Version 1.1

2 glides and 2 castors 20 \$

## Simpla - custom size ranges

Rough, reference information - please verify custom sizes with CS, especially for non-rectangular tabletops

**Rectangle:** width 12"-40" | length 24"-80"

**Square:** 24"x24" - 48"x48"

**Round:** Ø34" - Ø48"

**Half-round:** 48"x24" - 80"x40"

Bar height is NOT available.

Reinforcement applied when the length is 64" or more















# Simpla

By John Bollen

The unique folding system makes Simpla radically different. In addition to a minimalist and elegant silhouette, the two-piece table is flexible and space-saving.

- Lift off top
- Unique flat folding frame
- 5 year warranty

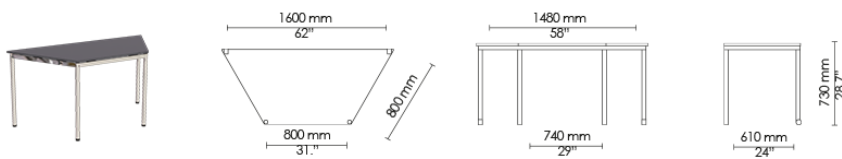
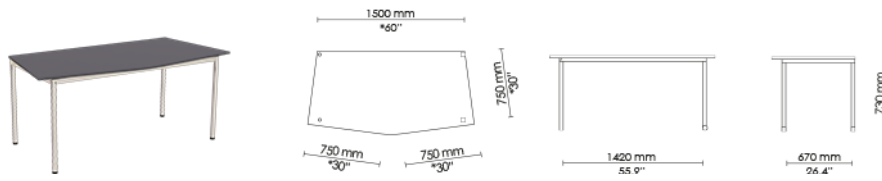

		Laminate (SGB)	Veneer (SGC)	
Laminate is with a matching ABS edge Veneer is standard with matching hardwood edge.  Table top thickness is 3/4" Standard frame with glides - optional to get glides and castors. Linking is incl. 2 brackets  		LU31  LU35  LU45  LU200  LU300  LU400 	VU1  VU3  VU5  VU15  LW17  LW25  LW30 	Linking
Trapezoid	60"x30" (1M2A)	\$ 2550	\$ 3187	\$ 31
				
V-Shaped	60"x30" (1E2C)	2755	3445	31
				
Round	Ø42" (1Z1J)	2670	3340	31
Round	Ø48" (2B1K)	2868	3587	

Price List 2024 - USD excl. sales tax - Version 1.1

2 glides and 2 castors 20 \$

**Simpla - custom size ranges**

Rough, reference information - please verify custom sizes with CS, especially for non-rectangular tabletops

**Round:** Ø34" – Ø48"

Bar height is NOT available.

# Simpla modesty panel

By John Bollen

The unique folding system makes Simpla radically different. In addition to a minimalist and elegant silhouette, the two-piece table is flexible and space-saving.



Modesty panel		
Simpla modesty panel in perforated steel, 9.8" high, with integrated cable tray and hooks to hang it on the Simpla frame.		Steel (SPS)
Simpla modesty panel in acrylic, 0.16" thick and 9.8" high, made of greenish acrylic plastic, mounted on the hooks.		\$
For 48" tops	(3C3CGHY/DEDEY)	443
For 60" tops	(3D3DGHY/DHDHY)	517
For 72" tops	(3F3FGHY/DKDKY)	517

Price List 2024 - USD excl. sales tax - Version 1.1

# Tempest flip top

By KOMPLOT Design

Detail is everything. It is why the Tempest flips, rolls and unfolds possibilities like no other table system in the world.

- 10 year warranty
- World's leading flip-top table system
- Nesting depth of 5.1"
- 6 tables can be stacked on table transporter
- Elegant elliptical leg-design
- GreenTag<sup>Cert</sup>™
- **Quick ship - LINK**

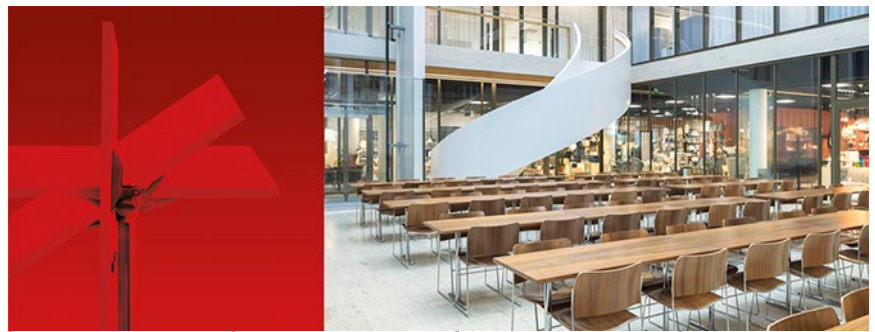

		Laminate (TPB)	Veneer (TPC)	Stained veneer (TPC)	
Laminate is with matching ABS edge		LU31	VU1	LW17	Linking
Veneer is with matching hardwood edge. Other RAL colours available - ASK HOWE		LU35	VU3	LW25	
		LU45	VU5	LW30	
Table top thickness is 1 1/8"		LU200	VU15		
Standard frame with glides and castors		\$	\$	\$	\$
Rectangular	48" x 24" (021B)	2021	3327	3831	304
Rectangular	48" x 30" (021M)	2078	3444	3948	
Rectangular	60" x 30" (021O)	2155	3601	4105	
Rectangular	72" x 30" (031Q)	2248	3758	4262	
Rectangular	72" x 36" (031R)	2480	3933	4437	
Rectangular	78" x 40" (031V)	2802	4266	4770	
V-Shape	60" x 30" (022C)	2647	4109	4613	N/A

Price List 2024 - USD excl. sales tax - Version 1.1

## Tempest flip T/TT legs - custom size ranges

Rough, reference information - please verify custom sizes with CS, especially for non-rectangular tabletops

**Rectangle:** length 32"-80" | width 22"-42"

Bar height NOT available.

# Tempest flip top

By KOMPLOT Design

Detail is everything. It is why the Tempest flips, rolls and unfolds possibilities like no other table system in the world.

- 10 year warranty
- World's leading flip-top table system
- Nesting depth of 5.1"
- 6 tables can be stacked on table transporter
- Elegant elliptical leg-design
- GreenTag<sup>Cert™</sup>

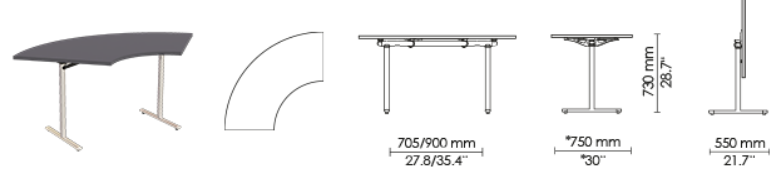
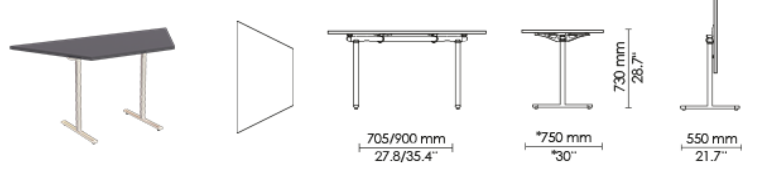
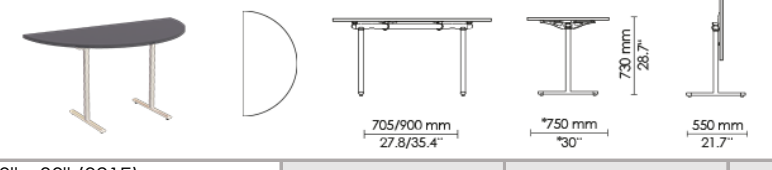

		Laminate (TPB)	Veneer (TPC)	Stained veneer (TPC)	
Laminate is with matching ABS edge		LU31	VU1	LW17	Linking
Veneer is with matching hardwood edge. Other RAL colours available - ASK HOWE		LU35	VU3	LW25	
		LU45	VU5	LW30	
Table top thickness is 1 1/8"		LU200	VU15		
Standard frame with glides and castors		LU300			
		LU400			
		\$	\$	\$	\$
					
Crescent	48" x 30" (O21C)	3071	4640	5144	304
Crescent	60" x 30" (O21D)	3411	5064	5568	
					
Trapezoid	60" x 30" (O12A)	2334	3718	4222	N/A
					
Half-round	60" x 30" (O21E)	2302	3679	4183	152

Price List 2024 - USD excl. sales tax - Version 1.1

# Tempest fold

By KOMPLOT Design

Detail is everything. It is why the Tempest flips, rolls and unfolds possibilities like no other table system in the world.

- 10 year warranty
- Inverted elliptical T-leg style
- Legs: concealed wheel + adjustable glides
- 5 tables can be stacked on table transporter



	Laminate (TDB)	Veneer (TDC)	Stained veneer (TDC)		
Laminate is with matching ABS edge	LU31 LU35 LU45 LU200 LU300 LU400	VU1 VU3 VU5 VU15	LW17 LW25 LW30	Linking	
Veneer is with matching hardwood edge. Other RAL colours available - ASK HOWE					
Table top thickness is 1 1/8"					
Standard frame with glides and castors	\$	\$	\$	\$	
Rectangular	48" x 24" (041L)	2244	4009	4559	304
Rectangular	48" x 30" (041M)	2301	4129	4679	
Rectangular	60" x 30" (051O)	2506	4294	4844	
Rectangular	72" x 30" (051Q)	2582	4460	5010	
Rectangular	72" x 36" (051R)	2811	4642	5192	
Conference					304
Rectangular	84" x 42" (051S)	4608	5760	5760	
Rectangular	96" x 48" (051W)	5094	6368	6368	

Price List 2024 - USD excl. sales tax - Version 1.1

## Tempest fold T/T legs - custom size ranges

Rough, reference information - please verify custom sizes with CS, especially for non-rectangular tabletops

**Rectangle:** length 40"-96" | width 22"-48"

Bar height NOT available.

# Tempest fold

By KOMPLOT Design

Detail is everything. It is why the Tempest flips, rolls and unfolds possibilities like no other table system in the world.

- 10 year warranty
- Inverted elliptical T-leg style
- Legs: concealed wheel + adjustable glides
- 5 tables can be stacked on table transporter



	Laminate (TDB)	Veneer (TDC)	Stained veneer (TDC)		
Laminate is with matching ABS edge	LU31 LU35 LU45 LU200 LU300 LU400	VU1 VU3 VU5 VU15	LW17 LW25 LW30	Linking	
Veneer is with matching hardwood edge. Other RAL colours available - ASK HOWE					
Table top thickness is 1 1/8"					
Standard frame with glides and castors	\$	\$	\$	\$	
Crescent	48" x 30" (041C)	N/A	5377	5927	304
Crescent	60" x 30" (051D)	N/A	5824	6374	
Trapezoid	60" x 30" (052A)	N/A	4417	4967	N/A

Price List 2024 - USD excl. sales tax - Version 1.1

# Tempest fold

By KOMPLOT Design

Detail is everything. It is why the Tempest flips, rolls and unfolds possibilities like no other table system in the world.

- 10 year warranty
- Inverted elliptical T-leg style
- Legs: concealed wheel + adjustable glides
- 5 tables can be stacked on table transporter



	Laminate (TD2)	Veneer (TD3)	Stained veneer (TD3)	
<p>Laminate is with matching ABS edge</p> <p>Veneer is with matching hardwood edge. Other RAL colours available - ASK HOWE</p> <p>B1 B6 B7 B9 B10 B30</p> <p>Table top thickness is 1 1/8"</p> <p>Standard frame with glides and castors</p>	<p>LU31</p> <p>LU35</p> <p>LU45</p> <p>LU200</p> <p>LU300</p> <p>LU400</p>	<p>VU1</p> <p>VU3</p> <p>VU5</p> <p>VU15</p>	<p>LW17</p> <p>LW25</p> <p>LW30</p>	Linking
	\$	\$	\$	\$
V-Shape 60" x 30" (052C)	N/A	4827	5377	N/A
Half-round 60" x 30" (051E)	N/A	4377	4927	152

Price List 2024 - USD excl. sales tax - Version 1.1



# Tempest fix

By KOMPLOT Design

Detail is everything. It is why the Tempest flips, rolls and unfolds possibilities like no other table system in the world.

- 10 year warranty
- Inverted elliptical T-leg style
- Legs: concealed wheel + adjustable glides
- GreenTag<sup>Cert™</sup>



	Laminate (TI2)	Veneer (TI3)	Stained veneer (TI3)	
<p>Laminate is with matching ABS edge</p> <p>Veneer is with matching hardwood edge. Other RAL colours available - ASK HOWE</p> <p>B1 B6 B7 B9 B10 B30</p> <p>Table top thickness is 1 1/8"</p> <p>Standard frame with glides and castors</p>	<p>LU31</p> <p>LU35</p> <p>LU45</p> <p>LU200</p> <p>LU300</p> <p>LU400</p>	<p>VU1</p> <p>VU3</p> <p>VU5</p> <p>VU15</p>	<p>LW17</p> <p>LW25</p> <p>LW30</p>	Linking
	\$	\$	\$	\$
Rectangular	48" x 24" (061L)	2378	2971	3464
Rectangular	48" x 30" (061M)	2464	3079	3572
Rectangular	60" x 30" (061O)	2578	3221	3714
Rectangular	72" x 30" (061Q)	2686	3356	3849
Rectangular	72" x 36" (061R)	2814	3516	4009
Half-round	60" x 30" (061E)	2631	3288	3781

Price List 2024 - USD excl. sales tax - Version 1.1

### Tempest fix T/T legs - custom size ranges

Rough, reference information - please verify custom sizes with CS, especially for non-rectangular tabletops

**Rectangle:** length 32"-96" | width 22"-55"

Bar height NOT available.

# Tempest fix

By KOMPLOT Design

Detail is everything. It is why the Tempest flips, rolls and unfolds possibilities like no other table system in the world.

- 10 year warranty
- Inverted elliptical T-leg style
- Legs: concealed wheel + adjustable glides
- GreenTag<sup>Cert™</sup>



	Laminate (TI2)	Veneer (TI3)	Stained veneer (TI3)		
Laminate is with matching ABS edge	LU31 LU35 LU45 LU200 LU300 LU400	VU1 VU3 VU5 VU15	LW17 LW25 LW30	Linking	
Veneer is with matching hardwood edge. Other RAL colours available - ASK HOWE	B1 B6 B7 B9 B10 B30				
Table top thickness is 1 1/8"					
Standard frame with glides and castors	\$	\$	\$	\$	
Crescent	48" x 30" (061C)	3317	4144	4637	304
Crescent	60" x 30" (061D)	3617	4520	5013	
Trapezoid	60" x 30" (062A)	2659	3323	3816	N/A
V-Shape	60" x 30" (062C)	2935	3668	4161	N/A

Price List 2024 - USD excl. sales tax - Version 1.1















# Tempest café flip top

By KOMPLOT Design

Detail is everything. It is why the Tempest flips, rolls and unfolds possibilities like no other table system in the world.

- 10 year warranty
- World's leading flip-top table system
- X-leg style with 4 adjustable glides
- Elegant elliptical leg-design
- GreenTag<sup>Cert™</sup>
- Table base is 100% recyclable

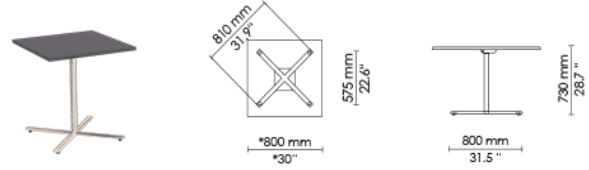
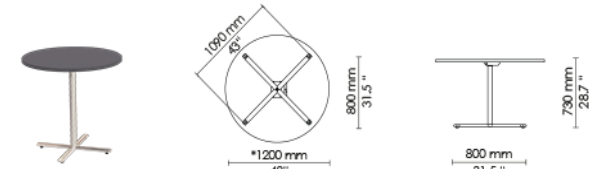

		Laminate (TLB)	Veneer (TLC)	Stained veneer (TLC)	
Laminate is with matching ABS edge Veneer is with matching hardwood edge. Other RAL colours available - ASK HOWE   B1 B6 B7 B30  Table top thickness is 1 1/8"  Standard frame with 4 glides		LU31  LU35  LU45  LU200  LU300  LU400 	VU1  VU3  VU5  VU15 	LW17  LW25  LW30 	Linking
		\$	\$	\$	\$
					
Square	30" x 30" (121Z)	2048	2928	3307	304
					
Round	Ø30" (111H)	1935	3040	3419	N/A
Round	Ø36" (221I)	2058	3363	3742	
Round	Ø42" (321J)	2328	3762	4141	
Round	Ø48" (331K)	2382	3886	4265	

Price List 2024 - USD excl. sales tax - Version 1.1

### Tempest flip cafe - custom size ranges

Rough, reference information - please verify custom sizes with CS, especially for non-rectangular tabletops

**Square:** 18"x18" - 40"x40"

**Round:** Ø24- Ø48"

# Tempest café and lounge fix

By KOMPLOT Design

Detail is everything. It is why the Tempest flips, rolls and unfolds possibilities like no other table system in the world.

- 10 year warranty
- Fixed base
- X-leg style with 4 adjustable glides
- Elegant elliptical leg-design
- GreenTag<sup>Cert™</sup>
- Table base is 100% recyclable



		Laminate (TNB)	Veneer (TNC)	Stained veneer (TNC)	
Laminate is with matching ABS edge		LU31	VU1	LW17	Linking
Veneer is with matching hardwood edge. Other RAL colours available - ASK HOWE		LU35	VU3	LW25	
 B1 B6 B7 B30		LU45	VU5	LW30	
Table top thickness is 1 1/8"		LU200	VU15		
Standard frame with 4 glides		LU300			
		LU400			
		\$	\$	\$	\$
Square	30" x 30" (121Z)	2023	2524	2902	304
					N/A
Round	Ø30" (111H)	2113	2636	3014	
Round	Ø36" (221I)	2275	2838	3216	
Round	Ø42" (321J)	2594	3236	3614	
Round	Ø48" (331K)	2694	3361	3739	
					N/A
Lounge - height	24" x 24" (121Y)	1837	2324	2702	

Price List 2024 - USD excl. sales tax - Version 1.1

## Tempest fix café - custom size ranges

Rough, reference information - please verify custom sizes with CS, especially for non-rectangular tabletops

**Square:** 18"x18" - 40"x40"

**Round:** Ø24-Ø48"

# Tempest bar flip top

By KOMPLOT Design

Detail is everything. It is why the Tempest flips, rolls and unfolds possibilities like no other table system in the world.

- 10 year warranty
- World's leading flip-top table system
- X-leg style with 4 adjustable glides
- Elegant elliptical leg-design
- GreenTag<sup>Cert™</sup>
- Table base is 100% recyclable



		Laminate (TLB)	Veneer (TLC)	Stained veneer (TLC)	
Laminate is with matching ABS edge					Linking
Veneer is with matching hardwood edge. Other RAL colours available - ASK HOWE					
 B1 B6 B7 B30		LU31 LU35 LU45 LU200 LU300 LU400	VU1 VU3 VU5 VU15	LW17 LW25 LW30	
Table top thickness is 1 1/8"					
Standard frame with 4 glides		\$	\$	\$	\$
Square	30" x 30" (121Z)	2074	2969	3348	304
Square	36" x 36" (232L)	2317	3255	3634	
Round	Ø30" (111H)	1962	3081	3460	N/A
Round	Ø36" (221I)	2084	3444	3823	

Price List 2024 - USD excl. sales tax - Version 1.1

## Tempest flip bar - custom size ranges

Rough, reference information - please verify custom sizes with CS, especially for non-rectangular tabletops

**Square:** 18"x18" - 40"x40"

**Round:** Ø24" - Ø40"

# Tempest bar fix

By KOMPLOT Design

Detail is everything. It is why the Tempest flips, rolls and unfolds possibilities like no other table system in the world.

- 10 year warranty
- Fixed base
- X-leg style with 4 adjustable glides
- Elegant elliptical leg-design
- GreenTag<sup>Cert™</sup>
- Table base is 100% recyclable



		Laminate (TNB)	Veneer (TNC)	Stained veneer (TNC)	
Laminate is with matching ABS edge					
Veneer is with matching hardwood edge. Other RAL colours available - ASK HOWE					
 B1 B6 B7 B30		LU31 LU35 LU45 LU200 LU300 LU400	VU1 VU3 VU5 VU15	LW17 LW25 LW30	Linking
Table top thickness is 1 1/8"					
Standard frame with 4 glides		\$	\$	\$	\$
Square	30" x 30" (121Z)	2064	2565	2943	304
Square	36" x 36" (232L)	2206	2730	3108	
Round	Ø30" (111H)	2154	2677	3055	N/A
Round	Ø36" (221I)	2356	2919	3297	

Price List 2024 - USD excl. sales tax - Version 1.1

**Tempest fix bar - custom size ranges**

Rough, reference information - please verify custom sizes with CS, especially for non-rectangular tabletops

**Square:** 18"x18" – 40"x40"

**Round:** Ø24" – Ø40"









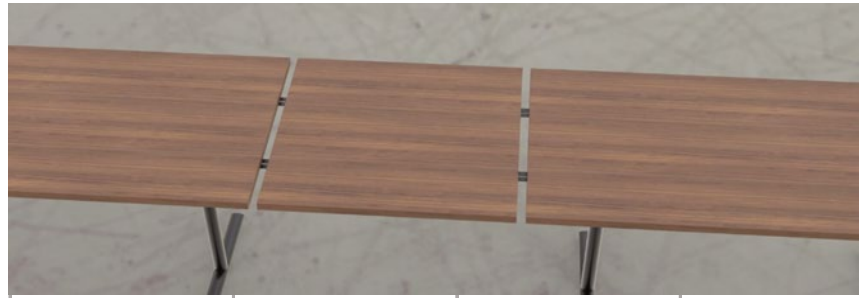



# Tempest drop-in top

By KOMPLOT Design

Detail is everything. It is why the Tempest flips, rolls and unfolds possibilities like no other table system in the world.

- 10 year warranty



	Laminate (TTB)	Veneer (TTC)	Stained Veneer (TTC)
<p>Laminate is with matching ABS edge</p> <p>Veneer is with matching hardwood edge.</p> <p>Top thickness is 1 1/8"</p> <p>They can be placed only in straight line between two other tables with straight edges: Linking is included. They cannot be equipped with any accessories.</p>	<p>LU31 </p> <p>LU35 </p> <p>LU45 </p> <p>LU200 </p> <p>LU300 </p> <p>LU400 </p>	<p>VU1 </p> <p>VU3 </p> <p>VU5 </p> <p>VU15 </p>	<p>LW17 </p> <p>LW25 </p> <p>LW30 </p>
	\$	\$	\$
Square	30" x 30" (1Z1Z)	949	1116
			1465

Price List 2024 - USD excl. sales tax - Version 1.1

# Tempest modesty panel

By KOMPLOT Design

Detail is everything. It is why the Tempest flips, rolls and unfolds possibilities like no other table system in the world.

- 10 year warranty



		Laminate	Veneer	Stained veneer
<b>MODESTY PANEL - Hook (MH)</b>  Rectangular modesty panel, on hooks, panel height 9,8". Suitable for rectangular flip-top, fold or fixed tables. *standard colour, same as tabletop		● LU31 ● LU35 ● LU45 ● LU200 □ LU300 ● LU400	● VU1 ● VU3 ● VU5 ● VU15	● LW17 ● LW25 ● LW30
		\$	\$	\$
Rectangular	30" long tops (3A3A)	444	644	821 *
Rectangular	48" long tops (3C3C)	471	679	856 *
Rectangular	60" long tops (3D3D)	524	732	909 *
Rectangular	72" long tops (3F3F)	548	756	933 *
<b>MODESTY PANEL - Demountable</b>  Rectangular modesty panel, on hooks, panel height 9,8". Suitable for rectangular flip-top or fixed tables. *standard colour, same as tabletop		Laminate	Veneer	Stained Veneer
Rectangular	30" long tops (3A3A)	467	667	844 *
Rectangular	48" long tops (3C3C)	496	705	882 *
Rectangular	60" long tops (3D3D)	549	758	935 *
Rectangular	72" long tops (3F3F)	573	781	958 *
<b>MODESTY PANEL - Retractable</b>  Rectangular modesty panel, on hooks, panel height 9,8". Suitable for rectangular fold tables. *standard colour, same as tabletop		Laminate	Veneer	Stained Veneer
Rectangular	30" long tops (3A3A)	787	987	1164 *
Rectangular	48" long tops (3C3C)	816	1025	1202 *
Rectangular	60" long tops (3D3D)	869	1078	1255 *
Rectangular	72" long tops (3F3F)	893	1101	1278 *

\*Color fee of USD 135 per color per order

Price List 2024 - USD excl. sales tax - Version 1.1















# Tutor

By John Bollen

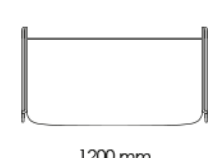
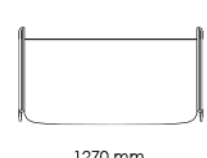
This stackable table pays tribute to the iconic 40/4 chair, and in the process, becomes an icon itself.

- Up to 30 tables can be stacked on dolly
- Up to 10 tables can be stacked on floor
- Use in education and training establishments
- 5 year warranty

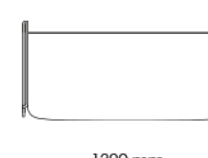
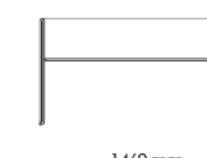

		Compact Laminate (OFA)			
Table top thickness is 1/4" bendable compact laminate. Other compact laminate colours: ask HOWE Other RAL colours - ask HOWE		F300 <input type="radio"/>	F200 <input type="radio"/>	With felt glides (F)	
 B1 B7 B9 B10 B30		\$		\$	
 600 mm 23.6"		 670 mm 26.4"	 665 mm 26.2"	 720 mm 28.3"	 800 mm 31.5"
Single table	23.6" (AA)	1150		1177	
 1200 mm 47.2"		 1270 mm 50"	 665 mm 26.2"	 720 mm 28.3"	 800 mm 31.5"
Double table	47.2" (BA)	1684		1711	
*Suitable for side chairs					
 1390 mm 54.7"		 1460 mm 57.5"	 665 mm 26.2"	 720 mm 28.3"	 800 mm 31.5"
*Double table	54.7" (CA)	2037		2064	
*Suitable for armchairs and swivel chairs					

Price List 2024 - USD excl. sales tax - Version 1.1

Net price: RAL K7 colours for frame - see notes

## HOWE table size ranges

Tutor US custom-size tabletops are not possible.



# Usu

By HOWE in-house design team

Usu is a study of simplicity in both form and function. The intuitive folding mechanism and transporter, with room for ten rectangular and square tables, make Usu easy to move.

- 5 year warranty
- Up to 10 rectangular and square tables stacked on a transporter
- Stylish round 4-leg design
- Design for disassembly



		Laminate (UFB)
Laminate is with matching ABS edge Table top thickness is 3/4" Standard frame with 2 glides and 2 castors. Linking is incl. 2 brackets		LU300 <input type="radio"/> LU400 <input type="radio"/> LU200 <input type="radio"/>
 *Due to the technological process, the black may slightly differ in terms of its gloss.		\$
		
Rectangular	48"x24" (1L1L)	1096
Rectangular	60"x24" (2D2D)	1181
Rectangular	72"x24" (2N2N)	1255
Rectangular	48"x30" (1M1M)	1162
Rectangular	60"x30" (1O1O)	1240
Rectangular	72" x 30" (1Q1Q)	1325
Rectangular	72" x 36" (1R1R)	1596
Round	Ø48" (1K1K)	1353

Price List 2024 - USD excl. sales tax - Version 1.1

\*\* Chrome base 118 \$

## HOWE table size ranges

Usu US custom-size tabletops are not possible.

# AS400

By Andreas Störiko

The AS series is highly inspired and highly functional. Combining elegance and utility with true mobility, the family of nesting chairs and tables leaves room for all imaginable purposes.

- 10 year warranty
- Café height tables
- Unbelievably easy to maneuver
- Intuitive flip-top mechanism
- Special handle allows to lift the AS tables
- Smart elastic cord firmly joins concave tables\*
- Rubber bumper protects tables from scratches
- An infinite number of tables can then be nested together

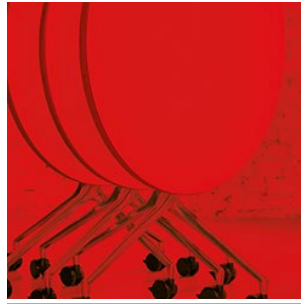

	Laminate (ABB)	Linoleum (ABD)	Veneer (ABC)
Table tops have an exposed plywood edge with transparent lacquer.	LU31 LU200 LU300 LU400	FL200	VU1 VU3
Other RAL colors available - ASK HOWE Standard base colors:			
	\$	\$	\$
Square 25.2" x 25.2" (*tiny pre-drills in the top; possibility to order linking later)	1314	1794	1949
Square with link 25.2" x 25.2"	1395	1875	2030
Round Ø32.7"	1314	1794	1949
Concave with link Ø32.7"	1422	1911	2074

Price List 2024 - USD excl. sales tax - Version 1.1

Soft castors for hard floor: 18 \$

## HOWE table size ranges

AS400 Custom-size tabletops are not possible.







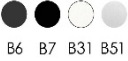

# AS500

By Andreas Störko

The AS series is highly inspired and highly functional. Combining elegance and utility with true mobility, the family of nesting chairs and tables leaves room for all imaginable purposes.

- 10 year warranty
- Bar height tables
- Unbelievably easy to maneuver
- Intuitive flip-top mechanism
- Special handle allows to lift the AS tables
- Smart elastic cord may join square tables together\*
- Rubber bumper protects tables from scratches
- An infinite number of tables can then be nested together

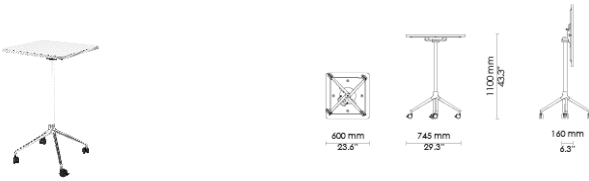
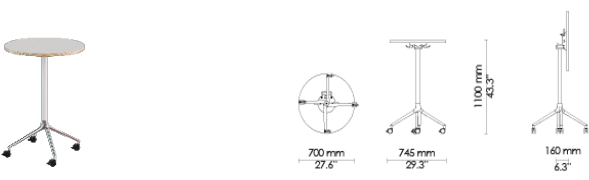

	Laminate (ADB)	Linoleum (ADD)	Veneer (ADC)
<p>Table tops have an exposed plywood edge with transparent lacquer.</p> <p>Other RAL colors available - ASK HOWE Standard base colors:</p>  <p>B6 B7 B31 B51</p>	<p>LU31 </p> <p>LU200 </p> <p>LU300 </p> <p>LU400 </p>	<p>FL200 </p>	<p>VU1 </p> <p>VU3 </p>
	\$	\$	\$
			
<p>Square 23.6" x 23.6" (*tiny pre-drills in the top; possibility to order linking later)</p>	1408	1901	2064
<p>Square with link 23.6" x 23.6"</p>	1489	1982	2145
			
<p>Round Ø27.6"</p>	1408	1901	2064

Price List 2024 - USD excl. sales tax - Version 1.1

Soft castors for hard floors

18

\$

## HOWE table size ranges

AS500 Custom-size tabletops are not possible.

# Folding surfaces

By Jones & Partners

With Folding Surfaces, users gain the ability to adjust their office space as necessary. This innovative product concept allows users to unfold a surface wherever needed, thereby redefining workspace dynamics.

- Cleverly integrated power solutions
- One of the largest mobile double-folding benches on the market
- Fold and tuck away the tables when not in use
- Modern, aesthetic look
- Intuitive and effortless handling
- Surface levelling feature



	Melamine*	Laminate	Veneer*
	FS1	FS2	FS3
Melamine and laminate are standard with matching ABS edge. Veneer is with matching hardwood edge. Table top thickness is 25 mm - melamine; 27 mm laminate and veneer Standard B6 satin black frame, 4 castors.	M310*	LU200 LU300	V3*
	\$	\$	\$
<b>Square 60" x 60" (1010)</b>			
<b>without</b> electrification	3,140	4,200	4,580
<b>Electrification cover top (CUT-OUTS ONLY)</b> - incl. cover top, metal tray, felt cover. 2x cut-outs for battery, 2x cut-outs for pip (excl. battery and pip)	3,968	6,121	6,501
<b>Electrification cover top (incl. pip, excl battery)</b> - incl. cover top, metal tray, felt cover. 2x cut-outs for battery, 2x cut-outs for pip, interconnecting cables, pip, battery docking (excl. battery)	5,283	7,436	7,816
<b>Rectangular 96" x 60" (6C6C)</b>			
<b>without</b> electrification	3,660	5,200	5580
<b>Electrification cover top (CUT-OUTS ONLY)</b> - incl. cover top, metal tray, felt cover. 2x cut-outs for battery, 2x cut-outs for pip (excl. battery and pip)	4,860	7,628	8,008
<b>Electrification cover top (incl. pip, excl battery)</b> - incl. cover top, metal tray, felt cover. 2x cut-outs for battery, 2x cut-outs for pip, interconnecting cables, pip, battery docking (excl. battery)	6,175	8,943	9,323
<b>Battery**</b>			
Battery and high power USB charging module in a portable housing (all black)		1,461	

Price list 2024 - USD excl. V.A.T. - Version 1.1

\* longer lead time

\*\*Shipment only directly to the end customer or to a warehouse certified for storage and handling of dangerous goods  
OE deliveries within North America may have shipping fee.

This depends on the order value and is shown separately in the offer.

Please contact Customer Service for details.

# Accessories

## Folding Surfaces Mobile Power Unit

As a natural extension for the family, Folding Surfaces come with mobile power units that provide extra power on demand.



Per Piece

\$

<b>Folding Surfaces Mobile Power Unit</b>		
<b>White melamine</b>		
Single, Rectangular 30"		
Semi solution - preparation for battery, 1xQikdoc for battery, 2xPIP TUF-R A+C (HP)	1576	
Cut-outs only - preparation for battery, 1xCUT-OUT for battery, 2x CUT OUTS for pip TUF-R A+C (HP)	1128	
Double, Rectangular 60"		
Semi solution - preparation for battery, 2xQikdoc for battery, 4xPIP TUF-R A+C (HP)	2423	
Cut-outs only - preparation for battery, 2xCUT-OUT for battery, 4x CUT OUTS for pip TUF-R A+C (HP)	1536	
<b>Black laminate</b>		
Single, Rectangular 30"		
Semi solution - preparation for battery, 1xQikdoc for battery, 2xPIP TUF-R A+C (HP)	2182	
Cut-outs only - preparation for battery, 1xCUT-OUT for battery, 2x CUT OUTS for pip TUF-R A+C (HP)	1734	
Double, Rectangular 60"		
Semi solution - preparation for battery, 2xQikdoc for battery, 4xPIP TUF-R A+C (HP)	3706	
Cut-outs only - preparation for battery, 2xCUT-OUT for battery, 4x CUT OUTS for pip TUF-R A+C (HP)	2819	
<b>Battery*</b>		
Quickpack carry black - OE animate battery and high power USB charging module in a neat, portable housing	1461	



Price list 2024 - EUR excl. V.A.T. - Version 1.1

\*Shipment only directly to the end customer or to a warehouse certified for storage and handling of dangerous goods  
OE deliveries within North America may have shipping fee.  
This depends on the order value and is shown separately in the offer.  
Please contact Customer Service for details.

# Accessories

## Tables' transporters

HOWE combines simplicity and functionality with a focus on timeless originality. In every moving detail. This is why our furniture stacks, folds, rolls and creates flexible solutions like no other designs in the world.

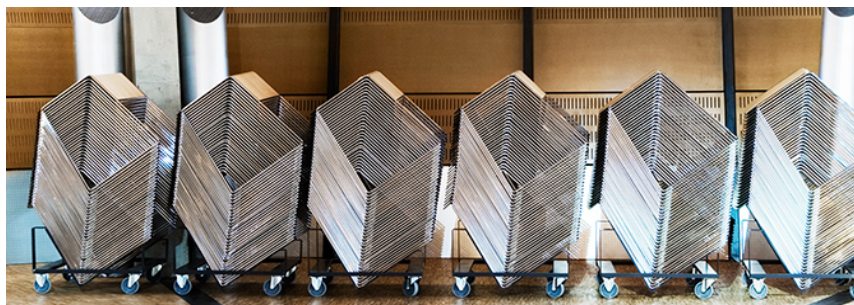

<b>Tempest Flip-top</b>		No.	Per Piece	
Capacity up to 5 tables standing up (flipped position). Dimensions: 38" high, 79" long and 36" wide. MDF platform, metal powdercoated in B10 Howe grey.				
Transporter	Tempest	TFTS0110	\$	3718
<b>Tempest Fold</b>			Per Piece	
Capacity: up to 10 pcs Stacks on table edge, secured with straps. Top against top - base against base. Colour B10 Howe grey. Dimensions: 44.5" high x 79" long x 22" wide. Suitable for length 48"-72" and width 24"-36".				
A-kit big	Tempest	UNTAS000110	\$	1788
<b>Only USU</b>			Per Piece	
Capacity: up to 10 pcs Stacks on table edge, secured with strap. Colour: black Height: 44.3", length: 45.5", depth: 17.7" The dimensions are without tables on the transporter. Suitable for rectangular and square tables 31.5" – 70.8" long and 19.7" – 35.4" wide				
Usu dolly	Usu	780TR001	\$	1716
<b>Tempest Fold</b>			Per Piece	
Capacity w/rectangular tables: up to 5 pcs Capacity w/ all other shapes: up to 5 pcs Stacks on table edge, secured with straps. Top against top - base against base. Colour B10 Howe grey. Dimensions: 49.5" high x 79" long x 30.5" wide. Suitable for length 84"-96" and width 42"-48" (when rectangular).				
L-kit	Tempest	UNTLS000310	\$	2317



Price List 2024 - USD excl. sales tax - Version 1.1

# Accessories

## Tables' transporters cont.

HOWE combines simplicity and functionality with a focus on timeless originality. In every moving detail. This is why our furniture stacks, folds, rolls and creates flexible solutions like no other designs in the world.



<b>Simpla</b>		No.	Per Piece	
Capacity up to 8 tables. Colour B10 Howe grey. Dimensions: height 74.5", depth 33", adjustable width Suitable for rectangular tables: length 40"-72" and width up to 36". For other shapes and sizes, please ask HOWE.				
Transporter	Simpla	STRA1000000 010	\$ 3003	
<b>Tutor single size</b>			Per Piece	
Capacity up to 30 tables. Suitable for single size Tutor tables. Color B10 Howe grey.				
Transporter	Tutor	OLYS0600SF1 0	\$ 1788	
<b>Tutor double size</b>			Per Piece	
Capacity up to 30 tables. Suitable for double size Tutor tables. Colour B10 Howe grey.				
Transporter	Tutor	OLYS1200SS1 0	\$ 2145	

Price List 2024 - USD excl. sales tax - Version 1.1





# Accessories

## Linking

HOWE combines simplicity and functionality with a focus on timeless originality. In every moving detail. This is why our furniture stacks, folds, rolls and creates flexible solutions like no other designs in the world.

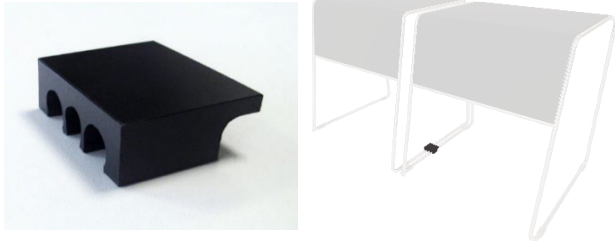

Linking for Usu tables		No.	Per Piece	
Usu linking bracket, black, 1 pcs*			\$	
Linking	Usu	780LS001	11	
Linking for Simpla tables			Per Piece	
Simpla linking U-bracket, B1 Chrome, 1 pcs*			\$	
Linking	Simpla	SAU01	31	
Linking for Tutor tables			Per Piece	
Tutor linking bracket, B7 Black			\$	
Linking	Tutor	TUA1480	36	
Linking for Tutor tables			Per Piece	
Tutor file tray* linking, B30 White			\$	
Linking	Tutor	TUA1490	286	

Price List 2024 - USD excl. sales tax - Version 1.1



# Accessories

## Grommets

HOWE combines simplicity and functionality with a focus on timeless originality. In every moving detail. This is why our furniture stacks, folds, rolls and creates flexible solutions like no other designs in the world.

All electrification solutions must be consulted with HOWE's Customer Service Team.



<b>Round</b>	No.	Per Piece	
SAPOP; white plastic Ø2 3/4"; suitable top thickness ≥ 3/4".			
		\$	
	SAPOP	49	
<b>Round</b>		Per Piece	
SAPOA; nature anodized aluminium with black brush, Ø3.5"; suitable top thickness ≥ 3/4".			
		\$	
	SAPOA	136	
<b>Rectangular</b>		Per Piece	
SAPRA <sup>1</sup> ; rectangular cable outlet comprised of two lids in nature anodized aluminium with black brushes; 12" x 4.25"; suitable top thickness ≥ 3/4".			
		\$	
	M1*	172	

Price List 2024 - USD excl. sales tax - Version 1.1

# Accessories

## Electrification

HOWE combines simplicity and functionality with a focus on timeless originality. In every moving detail. This is why our furniture stacks, folds, rolls and creates flexible solutions like no other designs in the world.

All electrification solutions must be consulted with HOWE's Customer Service Team.



Quickpack carry*	No.	Type	Prices from*	 
Quickpack carry black - OE animate battery and high power USB charging module in a neat, portable housing	OE4387596	Black	\$ 1461	
	OE4387602	White	1461	
Quick dock			Prices from	
Quick dock black by OE - dedicated container for QIKPAC CARRY portable battery; it locates and secures in/under surfaces	OE438765744 31572	Black	\$ 265	
	OE438766444 31572	White	265	
Charger				
Charger by OE - charging station for up to 3 QIKPAC batteries	OE6002275	charger black	1429	
	OE6002268	charger white	1429	
Wireless charge			Prices from	
A wireless charger by AH Byrne called Qi Charging Puck. The sleek grommet design can be quickly installed in any worksurface, and once in place, provides cord-free, tangle-free power for any Qi-enabled device. Forget packing your own charger, simply place your smartphone or tablet on our puck's surface and it's powering up – all from a single outlet. Wireless. Effortless.	BE07643	wireless charger	\$ 119	

Price List 2024 - USD excl. sales tax - Version 1.1

\*Shipment only directly to the end customer or to a warehouse certified for storage and handling of dangerous goods  
 OE deliveries within North America may have shipping fee.  
 This depends on the order value and is shown separately in the offer.  
 Please contact Customer Service for details.

# Accessories

## Cable trays, channels & fittings

HOWE combines simplicity and functionality with a focus on timeless originality. In every moving detail. This is why our furniture stacks, folds, rolls and creates flexible solutions like no other designs in the world.

All electrification solutions must be consulted with HOWE's Customer Service Team.



Cable tray	No.	Per Piece
L-shaped cable tray in black coated steel; mounted with screws; for table top thickness $\geq 3/4$ "; height of cable tray is 4"; works as a low modesty panel.		\$
15.75"	CTLS040007	72
25"	CTLL064007	107
33"	CTLL084007	143
41"	CTLL104007	172
Clickable cable channel Tempest		Per Piece
Cable channel for Tempest, in chrome powder coated aluminium as standard <sup>1</sup>		\$
Tempest	CHT053051	72
Clickable cable channel Moveo		Per Piece
Cable channel for Moveo, in anodised aluminium as standard <sup>1</sup>		\$
Moveo	CHM42052	33
Cable holder		Per Piece
Grey plastic cable holder to guide cables underneath the tabletop; 1pc double holder		\$
All tables	082011	N/A

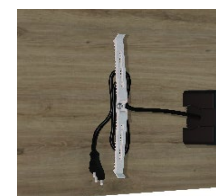



Price List 2024 - USD excl. sales tax - Version 1.1

# Accessories

## AS tables privacy screens

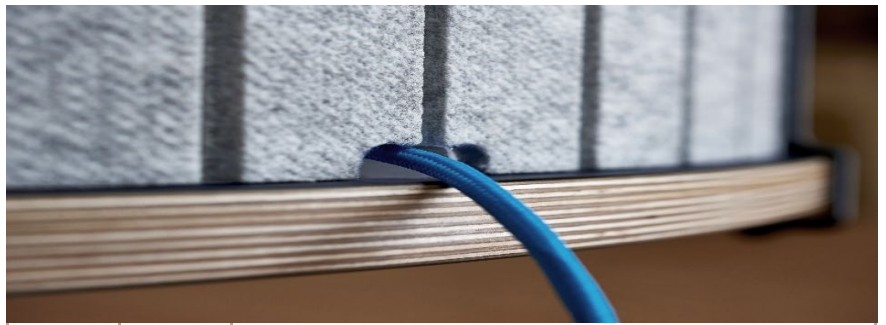
Aesthetically pleasing, the innovative felt privacy screen creates enclosure to spaces during work, education, and meeting areas. It gives flexibility to produce boundaries, as well as visual privacy.



Privacy screen	No.	Per Piece	
Privacy screen for AS round and round concave tables. 46.75"wide x13.75" high; 0.5 thick; light grey felt		\$	
Screen	66091001	572	

Price List 2024 - USD excl. sales tax - Version 1.1

# Notes for tables

Price list 2024 - USD excl. V.A.T. - Version 1.1

## General

---

HOWE Standard delivery time within North America is determined on a case-to-case basis – please contact Customer Service for details.

In case of large quantities and/or customized products delivery time is usually longer than for standard products.

In case of using any electrification, accessories, or making configurations, the lead time starts being counted once technical drawings are approved by the customer.

Linking is recommended to ensure strong connection and levelling. Please use for both temporary and lasting tables' arrangements.

Crescent shape – the inside curve of top may be exchanged for straight edge, especially if Modesty panels are needed – ask Customer Service for details.

Table ranges are estimates, mostly for rectangular tops. For non-rectangular tables or questions for sizes outside of the ranges, please contact your local Customer Service (CS) representative. If chamfered edges are requested, minimum size increases - check with CS.

## Moveo

---

Moveo linking for rectangular and V-shaped tables includes 4 brackets and 4 fittings. Moveo linking for half-round and half-boat tables includes 2 brackets and 2 fittings. This type of linking is available for tables with straight edges only. Another linking type is available for tables with chamfered edges. Here you also get 4 brackets and 4 fittings for rectangular and V-shape tables and 2 brackets and 2 fitting for half-round and half-boat tables.

All RAL colours from RAL K5 or K7 colour card available. For quantities < 20 tables the colour fee is 520 USD per RAL colour. For quantities ≥ 20 tables there is no fee. Visual impression of particular RAL may differ on various surfaces. Preparing product's sample(s) is compulsory. Lead time to be confirmed by HOWE CS.

## Simpla

---

Please note that Simpla linking does not need any pre-drills and may be ordered at any time as a separate accessory. There are 2 pcs of linking recommended per a set of two tables.

Please note that Modesty panels for Simpla are just hanged on the frame and may be ordered at any time as a separate accessory.

All RAL colours from RAL K5 or K7 colour card available. For quantities < 50 tables the colour fee is 520 USD per RAL colour. For quantities ≥ 50 tables there is no fee. Visual impression of particular RAL may differ on various surfaces. Preparing product's sample(s) is compulsory. Lead time to be confirmed by HOWE CS.

## Tempest

---

Tempest linking for rectangular, crescent, and square tables includes 4 brackets and 4 fittings. Tempest linking for half-round tables includes 2 brackets and 2 fittings. This type of linking is available for tables with straight edges only. Another linking type is available for tables with chamfered edges. Please contact HOWE for options.

All RAL colours from RAL K5 or K7 colour card available. For quantities < 20 tables the colour fee is 520 USD per RAL colour. For quantities ≥ 20 tables there is no fee. Visual impression of particular RAL may differ on various surfaces. Preparing product's sample(s) is compulsory. Lead time to be confirmed by HOWE CS.

## Usu

---

Please note that Usu linking may be ordered at any time as a separate accessory.

**Tutor**

---

All RAL colours from RAL K5 or K7 colour card available. For quantities < 50 tables the colour fee is 520 USD per RAL colour. For quantities ≥ 50 tables there is no fee. Visual impression of particular RAL may differ on various surfaces. Preparing product's sample(s) is compulsory. Lead time to be confirmed by HOWE CS.

40/4  
Seats / backs  
Natural wood  
veneers



V1 - maple



V2 - beech



V3 - oak



V5 - cherry



V12 - ash  
EMEA ONLY



V13 - birch  
EMEA ONLY



V15 - walnut

40/4  
Seats / backs  
Stains



LW17 - black



LW30 - white



Any RAL

All RAL colours available  
based upon customer sample

40/4  
Seats / backs  
Polyamide



PA200 - black

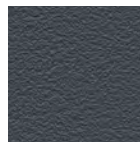

PA100 - Howe grey



PA300 - coconut



PA110 - Ayers Rock red



PA260 - marine blue

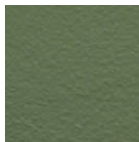

PA360 - olive green



PA320 - mandarin



PA250 - blue eyes



PA370 - mint turquoise



PA380 - aubergine

40/4  
Seats / backs  
Metal



ME200 - black



ME300 - white



ME110 - red  
EMEA ONLY



Any RAL

All RAL colours available  
based upon customer sample

40/4  
WOOD  
FRAME  
Seats / backs  
Natural wood  
veneers / stains



V2 - beech



V3 - oak



LW17 - black stain



LW25 - walnut stain

SixE  
Shells  
Polypropylene

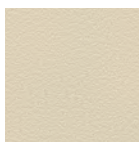

PP310 - wheat  
VIRGIN



PP270 - ocean  
VIRGIN



PP120 - red ochre  
50% RECYCLED



PP340 - fawn  
VIRGIN



PP350 - lichen  
VIRGIN

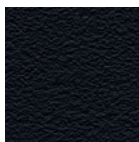

PP200 - black  
VIRGIN OR  
100% RECYCLED

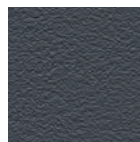

PP100 - Howe grey  
100% RECYCLED



PP300 - chalk  
VIRGIN OR  
50% RECYCLED

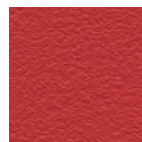

PP110 - Ayers Rock red  
VIRGIN



PP360 - olive green  
VIRGIN



# CHAIRS

EMEA  
NORTH AMERICA

MN1  
Backs  
Natural wood  
veneers / stains



V3 - oak



LW17 - black stain



LW25 - walnut stain

40/4  
SIXE  
Frames  
Steel



B1 - chrome

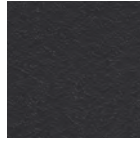

B6 - satin black



B7 - black

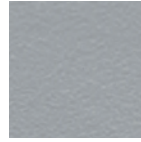

B9 - alu grey

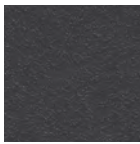

B10 - Howe grey



B30 - white



Any RAL

All RAL colours  
available based  
upon customer  
sample

SIXE  
ONLY

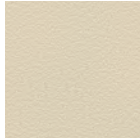

Wheat



Ocean



Red Ochre



Fawn



Lichen

SIXE SWIVEL  
SIXE LEARN  
Base  
Polyamide

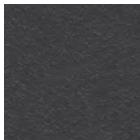

PA100 - Howe grey

SIXE SWIVEL  
SIXE LEARN\*  
Swing arm\*  
Gas lift

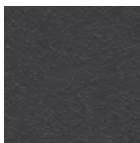

B10 - Howe grey

MN1  
Bases



B1 - chrome  
- Cantilever only



B7 - black



B51 - polished alu

AS100  
Bases / seat  
frames

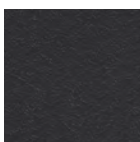

B6 - satin black



B7 - black



B51 - polished alu



AS TABLES  
MOVEO  
SIMPLA  
TEMPEST

Tops  
Natural wood  
veneers / stains



VU1 - maple



VU3 - oak



VU5 - cherry



VU15 - walnut

AS tables standard:  
VU1 maple, VU3 oak ONLY

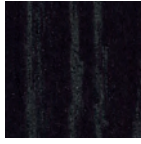

LW17 - black stain

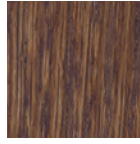

LW25 - walnut stain

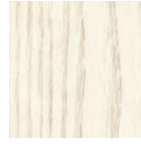

LW30 - white stain



Any RAL

All RAL colors available  
based upon customer sample

FOLDING SURFACES

Tops  
Natural wood  
veneers / stains



V3 - oak

AS TABLES  
MOVEO  
SIMPLA  
TEMPEST

Tops  
Wood grain  
laminates



LU31 - maple



LU35 - cherry

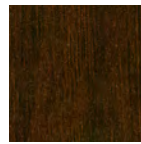

LU45 - walnut

AS tables standard:  
LU31 maple ONLY

AS TABLES  
FOLDING SURFACES  
MOVEO  
SIMPLA  
TEMPEST  
USU

Tops  
Coloured  
laminates



LU300 - white

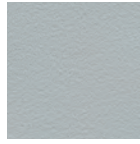

LU400 - grey



LU200 - black



Any FORMICA /  
WILSONART  
colored laminates

Folding Surfaces standard:  
LU300 white, LU200 black ONLY

\*Any FORMICA / WILSONART  
colored laminates does not apply  
to Usu and Folding Surfaces

TUTOR

Tops  
Bendable  
compact  
laminates



F300 - white

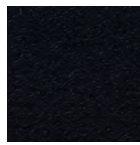

F200 - black



Any bendable  
compact laminate

AS TABLES

Tops  
Linoleums

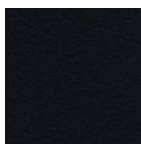

FL200 - black

FOLDING SURFACES

Tops  
Melamines

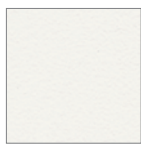

M310 - white



SIMPLA  
TUTOR

Bases  
Steel

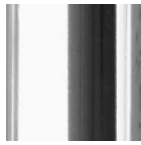

B1 - chrome



B7 - black

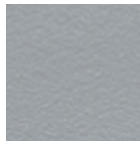

B9 - alu grey

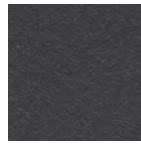

B10 - Howe grey



B30 - white

TEMPEST

Bases  
Steel

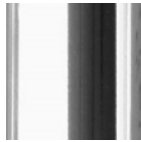

B1 - chrome



B6 - satin black

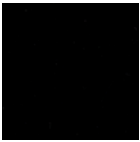

B7 - black

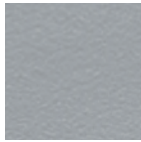

B9 - alu grey

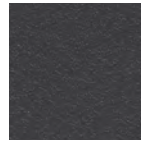

B10 - Howe grey



B30 - white

USU

Bases  
Steel

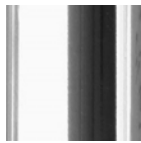

B1 - chrome



B7 - black

MOVEO

Bases  
Aluminum

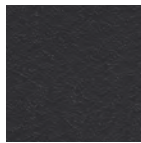

B6 - satin black

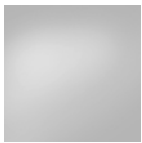

B51 - polished alu  
- feet only



B52 - anodized alu  
- columns only

AS TABLES

Bases

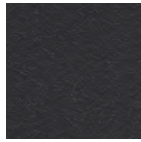

B6 - satin black



B7 - black



B31 satin white  
- columns only



B51 - polished alu  
- bases only

FOLDING SURFACES

Bases

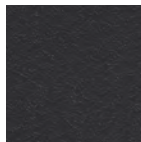

B6 - satin black



**TABLES**  
NORTH AMERICA



COLOUR REFERENCE ONLY  
Variations in colours and structures may occur  
Subject to ongoing changes and adjustments

→ [HOWE.COM](https://www.howe.com)

09.2024

# General conditions of sales

Price list 2024 - USD excl. V.A.T. - Version 1.1

## General

---

These general conditions of sale and terms of delivery shall apply to all agreements concluded between HOWE US Inc. (hereinafter HOWE) and its customers (hereinafter the Buyer), unless otherwise specifically agreed in writing between the Parties.

## Conclusion of agreements, etc.

---

An agreement has not been concluded until HOWE has accepted an offer made by the Buyer by issuing an order acknowledgement, an invoice or other such written agreement based on the terms and conditions specified in this document. All prices stated in price lists and catalogues include packaging, such as pallets and transport containers, and exclude taxes and/or any other charges. HOWE reserves the right to adjust the prices stated without prior warning in case of an increase in the price of raw materials, production costs, transport costs, packaging, or other sudden changes in the cost level. All agreements are thus concluded on the basis of the prices in force at the time when the order is received.

The agreement basis is thus the information, including information relating to price, materials, qualities, etc., that is stated in the order acknowledgement, invoice, or other such agreement, since other information shall be deemed to be for guidance only and may be corrected up until but not later than the time when the agreement is concluded. Unless otherwise explicitly agreed in writing, the goods have been sold for normal, standard use for the intended purpose.

An Order shall constitute an offer for the sale of goods and does not constitute an acceptance by Buyer of any offer to sell, any quotation, or any proposal. No Order shall become a binding contract for the sale of goods unless and until such Order has been received and accepted by HOWE us Inc. in the state of Michigan.

## Payment, etc.

---

Payment terms are subject to credit insurance at Coface. In case a customer cannot be insured a prepayment, or a bank guarantee will be required. If credit payment terms can be granted, payment shall be made in accordance with the terms of payment stated on the invoice, which basically means that payment shall be made in cash not later than 30 days after the date of invoice ("net 30 days"), unless otherwise explicitly agreed. The Buyer shall not be entitled to withhold any part of its' payments due and may under no circumstances offset. If payment is delayed, HOWE shall be entitled to charge interest at a rate of 0.75 % per month or part thereof from the due date. Also, HOWE shall at its' discretion be entitled to fully or partially withhold subsequent deliveries, to demand special terms of payment, or cancel agreements with the Buyer.

HOWE shall be entitled to charge the following fees:

- o A fee of thirteen (\$13) for each reminder on late payment
- o All invoices sent by paper will be added an invoice fee of five (\$5)

## Property reservation

---

HOWE shall retain property in all the goods stated in the order acknowledgement or other such written agreement until the full purchase sum has been paid. The Buyer shall keep the goods fully insured until such time as the purchase sum has been paid and during this period the Buyer shall be responsible towards HOWE for any all and any damage suffered by the goods. HOWE has the right to inspect the goods at any time.

## Delivery

---

'Unless otherwise agreed, delivery in Zone 1 in the US shall be made to the Buyer's warehouse situated on the ground floor at a price of two and a half (2½) % of the list price. Delivery in Zone 2 in the US shall be made to the Buyer's warehouse situated on the ground floor at a price of four and a half (4½) % of the list price. Outside Zone 1 and 2 the added price for delivery is determined on a case-to-case basis by HOWE.

HOWE Standard delivery time within North America is determined on a case-to-case basis – please contact Customer Service for details.

Regardless of whether the Buyer is present at the time of delivery, all risks in relation to the goods shall pass to the Buyer upon delivery to the agreed location. The Buyer shall ensure that the place of delivery is accessible and appropriately laid out for unloading the goods and storing them in their standard packages.

Any deviation from the terms of delivery shall be deemed to constitute one joint deviation from the above, in which case the Buyer shall take over the risk in relation to the goods at the earlier time when the goods were collected or could have been collected in accordance with the agreement made.

If the Buyer requests a postponement of delivery the following charges shall apply:

- o If the Buyer requests postponement no later than five workdays prior to the planned and confirmed time of dispatch, a supplementary charge of ten (\$10) per pallet shall be made per month or part thereof. Minimum charge, forty (\$40) per month or part thereof.
- o If the Buyer changes its' delivery address no later than five workdays prior to dispatch, an administrative charge of one hundred (\$100) shall be added.
- o If the sales price is below net five hundred (\$500) a freight charge of one hundred (\$100) will be added.
- o If the Buyer wishes a fixed delivery, a fee of five hundred (\$500) will be added.

#### BATTERIES' SHIPMENTS

OE batteries contain Lithium-Ion (Li-ion) cells which are classed as hazardous materials. As such they are individually packed in UN38.3 compliant packaging, including special Li Ion Battery Label. They should be kept in that packaging until they are either fitted in the furniture or get to the site for use.

If one consolidates the battery into an outer carton, it must remain in the box it is shipped to the person in inside the outer carton. The outer carton would then need to be marked with 'OVERPACK' word in English and the local language – the rules are even stricter for air freight - consult details with your freight forwarder (OE can supply UN38.3 certificates).

That is why at HOWE we:

- a) always place a separate order and use road shipments for batteries,
- b) strongly recommend shipping batteries directly to the end customer.

OE is experienced in shipping batteries to a number of international locations. Still, we strongly advise to state in advance to which country destination one is quoting for. On that basis we can confirm that battery export to the said country is allowed and possible.

In case the customer asks for the shipment to the warehouse, they must confirm the place is officially complying with all the regulations regarding storage and handling of dangerous goods which include:

- o Staff training on dangerous goods handling – chargeable course required (renewable every couple of years) – also a DGSA must to be appointed or trained,
- o Being equipped with fire proof cabinet storage,
- o Having Property owner and insurance authorisation.

#### **Fee and MOQ for non-standard choices**

---

For any non-standard product there is a \$500 fee. In most cases there is also a minimum order quantity (MOQ).

#### **Buyers' cancellation of contract**

---

Provided the manufacture/dispatch/delivery of the goods has not yet commenced the Buyer shall be entitled to cancel the contract up until forty-eight (48) hours after the order confirmation has been issued. A cancellation fee of 5% of the purchase sum and any extra loss incurred by HOWE as a consequence of the cancellation will apply. In the event more than five (5) workdays have passed since the order confirmation was issued, the contract may be cancelled only up until 4 (four) weeks before confirmed shipment time. A cancellation fee of fifty (50) % of the purchase sum plus transport and administration costs, and any extra loss incurred by HOWE as a consequence of the cancellation will apply. Following four (4) weeks before confirmed shipment time the contract cannot be cancelled.

#### **Delays**

---

The confirmed time of delivery is only an estimated deadline since HOWE shall be entitled to make changes to or temporarily postpone deliveries in order to be able to organize its goods deliveries and administration appropriately. HOWE cannot be held liable for any loss suffered by the Buyer as a result of a changed or postponed time of delivery. Furthermore, HOWE does not automatically offer loan furniture in these situations.

#### **Deficiencies, etc.**

---

HOWE shall only be liable for deficiencies in the goods sold if such deficiencies are the result of matters relating to the materials used or the craftsmanship applied. In particular, HOWE shall not be liable for matters resulting from wrong or abnormal use or storage, including in relation to climate and temperature conditions, or any other aspects related to HOWE's instructions.

When the risks in relation to the goods have passed to the Buyer, HOWE can only be held liable for faults and deficiencies to the extent specified in this provision.

The Buyer shall be obliged to carry out a detailed examination of the consignment immediately upon receipt. Complaints regarding deficiencies and/or visible transport damage which are – or should have been – discovered in this examination shall be written on the bill of landing (BOL), which must be given to carrier upon receipt of goods and HOWE CS notified. Any complaints regarding "non-visible" transport damage must reach HOWE not later than seven (7) days after the date of delivery and any complaints regarding any deficiencies ascertained must in each case be forwarded not later than seven (7) days after they were – or should have been – discovered. If the complaint is not made within these deadlines, the Buyer's access to advance claims in relation to any such deficiencies shall be forfeited.

A complaint shall be in writing and shall contain a specific description of the deficiencies with accompanying photo documentation or, alternatively, the deficient component/product shall be forwarded with the complaint.

Unless the deficiency ascertained is the result of gross negligence or intent on the part of HOWE, the Buyer shall in no instance not be entitled to any other rights than to have the goods replaced at no cost to the Buyer. Thus, the Buyer shall not be entitled to cancel the transaction or any rebate, damages, other compensation, or repayment. Further, HOWE shall under no circumstances whatsoever be liable for operating loss, loss of profit, time loss, other indirect loss or damages suffered by the Buyer as a consequence of deficiencies in the goods delivered.

The deficient goods belong to HOWE and shall be returned to HOWE upon request. Basically, the Buyer shall bear the costs and risk of such transport. Unless HOWE has explicitly undertaken to guarantee for the object sold for a longer period, HOWE shall under no circumstances be held liable for faults or deficiencies for which no written complaint has been sent within two years of the hand-over to the Buyer.

---

#### **Product liability**

The Buyer shall indemnify, defend, and hold harmless HOWE for any and all claims made by third parties for damage or injury for which HOWE is not liable towards the Buyer. HOWE's liability for product liability claims shall not exceed ten thousand (\$10,000), and HOWE shall under no circumstances be held liable to the Buyer for operating loss, loss of profit, time loss, other indirect loss or damages or punitive damages. The Buyer shall immediately inform HOWE of any lawsuit or type of claim for damage or injury caused by products manufactured by HOWE.

---

#### **Design alterations**

HOWE reserves the right at all times to make such changes to product design, etc., as HOWE deems to be necessary. In such case, information about significant alterations shall be forwarded to the Buyer prior to delivery.

---

#### **Use and maintenance guides**

The Buyer shall not change the content of Use- and Maintenance guides provided by HOWE. Further, the Buyer shall at all times provide its customers with copies of such guides and specifically draw the customers' attention to the warnings contained in the guides.

---

#### **No waiver**

If HOWE fails to exercise or claim its' rights under these Sales conditions, such failure shall not constitute a waiver of such right on the part of HOWE. Also, such failure shall not prevent the right to be invoked or claimed by HOWE at a later point in time.

---

#### **Venue and Service of Process**

If a dispute of any kind whatsoever arises between the Parties in connection with these Sales Conditions and other aspects in relation to the sales transaction, the Parties shall attempt to settle such dispute amicably.

Provided the Parties are not able to agree upon an amicable settlement within a reasonable time and not later than thirty (30) calendar days after initiation of settlement discussions, any controversy or claim arising (whether contractually or in tort) and including disputes regarding the validity of this provision shall be settled by the American Arbitration Association (AAA). The place of Arbitration shall be Grand Rapids, Michigan. Provided the dispute in question amounts to \$100,000.00 or less, the Arbitration Panel shall consist of one (1) arbitrator. Provided the dispute in question exceeds \$100,000.00 the Arbitration Panel

shall consist of three (3) arbitrators. The right to discovery shall be limited to the widest extent permitted by the AAA procedural rules.

The result of the Arbitration shall be final and binding upon the Parties, and the arbitrator(s) shall in their discretion have to power to award reasonable costs and attorney's fees to the prevailing Party.

Despite the arbitration procedure agreed upon above, the Parties shall not be precluded from carrying out interim measures via the appropriate judicial authority.

These Sales Conditions shall be governed by Michigan State law and applicable US Federal law.

Be advised that HOWE reserves the right to correct any printing errors, inaccuracies, or omissions.



# Shipping zone rates

Price list 2024 - USD excl. V.A.T. - Version 1.0

## Shipping zone rates

---

- For deliveries in zone 1 please add 2.5% to the list pricing. The minimum freight charge is \$200.
- For deliveries in zone 2 please add 4.5% to the list pricing. The minimum freight charge is \$200.
- For deliveries out of Zone 1 and 2, please ask HOWE.



# Warranties

Price list 2024 - USD excl. V.A.T. - Version 1.1

## General

---

At HOWE US we recognize the value of products that can stand up to continuous use, and we know by experience that good material combined with true craftsmanship and thorough design provides sturdy and durable furniture.

Our high and uniform quality policy secures that our products are always tested to the highest level of international standards and legislations. We constantly strive to optimize our products and services to maintain the high level of quality and durability that is expected of a HOWE product.

HOWE US warrants its products against defects in materials and workmanship as follows:

## Limited warranty

---

HOWE warrants its' products against defects in materials and workmanship as described in the following. All warranties are expressly limited to the types of warranties offered. Thus, no other implied or express warranties shall apply.

## 10 year warranty

---

HOWE offers on all chairs of its David Rowland 40/4 chair collection a 10 (ten) year guarantee under normal use against weld breakages, defective material, workmanship, and performance. Only exception is the 40/4 wood frame, which has a 5 (five) year guarantee.

The 40/4 chair is compliant with the following tests in the ANSI/BIFMA X5.1-2011 Chair Test Standard:

- Back Strength
- Drop-Dynamic
- Seating Durability
- Backrest Durability-Non-Tilt
- Leg Strength

HOWE offers on Moveo and Tempest table systems, SixE, MN1 and AS chairs a 10 (ten) year guarantee under normal use against weld breakages, defective material, workmanship, and performance. Excluded are: gas lifts, turn / tilt mechanism, castors, folding adaptors, where 5 (five) year guarantee applies.

## 5 year warranty

---

HOWE offers on all other furniture products, except Folding Surfaces, a 5 (five) year guarantee under normal use against weld breakages, defective material, workmanship, and performance.

## 2 year warranty

---

On all power and data solutions we refer to our sub supplier. Their warranty period is 2 (two) years. The HOWE guarantee period runs from the date of shipment.

HOWE offers on AS privacy screens and Folding Surfaces a 2 (two) year guarantee under normal use against weld breakages, defective material, workmanship, and performance.

## Exclusions

---

This warranty does not apply to product failure resulting from:

- Normal wear and tear
- Abuse, misuse, accidents, or repeated knocks
- Improper handling/usage or improper cleaning/maintenance
- Alteration or modification of the product

In addition, HOWE does not warrant:

- o Changes in surface finishes due to aging, scratches, markings, stains, or other damage due to normal wear and tear, or due to contact with sharp or hard objects
- o Changes in surface finishes due to exposure to light
- o Oxidizing of outdoor treated frames
- o Natural variations in wood grain or the presence of character marks. This includes matching of grains, colors, or textures of natural materials
- o Customers own fabrics and leather (COL & COM)
- o All service parts (meaning all moving and mechanical parts)
- o Customized solutions
- o Marks in fabric/leather after stacking of chairs
- o For leather: Marks as scars, insect bites, fat creases and neck wrinkles. This is beauty marks that reflect the normal life of an animal.

HOWE recommends chromium plated steel frames on all 40/4 chairs where repeated handling is intended. Please, be aware that constant impacts from handling of painted linking chairs are likely to cause scratches and flaking over time. This is considered normal wear and tear and therefore not covered by the HOWE Warranty.

### **Original spare parts delivery guarantee**

---

Furniture programs from HOWE US are designed with focus on durability and timeless design. In case a product should be discontinued all original spare parts are available for 5 (five) years from the date the discontinuation has been carried through. If a component to a discontinued product for some reason is not available, a corresponding product is offered instead.

In case David Rowlands 40/4 chair should be discontinued all original spare parts are available for 10 (ten) years from the date the discontinuation has been carried through. In case the Tempest and Moveo table systems or the SixE chair family should be discontinued all original spare parts are available for 10 (ten) years from the date the discontinuation has been carried through.

The guarantee does not apply to product and component modifications and enhancements.